

**Noise & gain  
measures from 2 to 18  
GHz with Eaton 2075  
& HP 8971b and adds**



F5DQK February 2009 part 2/4 2 to 18 GHz NF+gain measuring with Eaton 2075 or HP 8970b and ADDS

# Overview

- This 2nd Powerpoint is illustrating hits and kinks about gain and NF measurements OVER 2 GHz with both Eaton 2075a and HP or Agilent 8970a analysers.
- Solutions are covering the 2 – 18 and up to 26 GHz band

## PART 2

# MEASUREMENTS WITH EXTERNAL MIXER

# Abstract

## **1- The solutions in the industrial world:**

- HP-8971b or c NF extension test-set
- Eaton NGA frequency extender

## **2- Direct low-cost DSB measurements using a single broadband mixer**

## **3- X, Y and Z outputs to an oscilloscope**

## **4- Calibration of unknown noise sources from 2 to 18 GHz**

## **5- Conclusions**

# 1- The solutions in the industrial world

# The choice in the industrial world

## Agilent HP 8971b (or c model) noise figure test-set

- Model b goes up to 18 GHz and c, up to 26 GHz
- 2 GPIB cables needed between analyser, extension and sweep

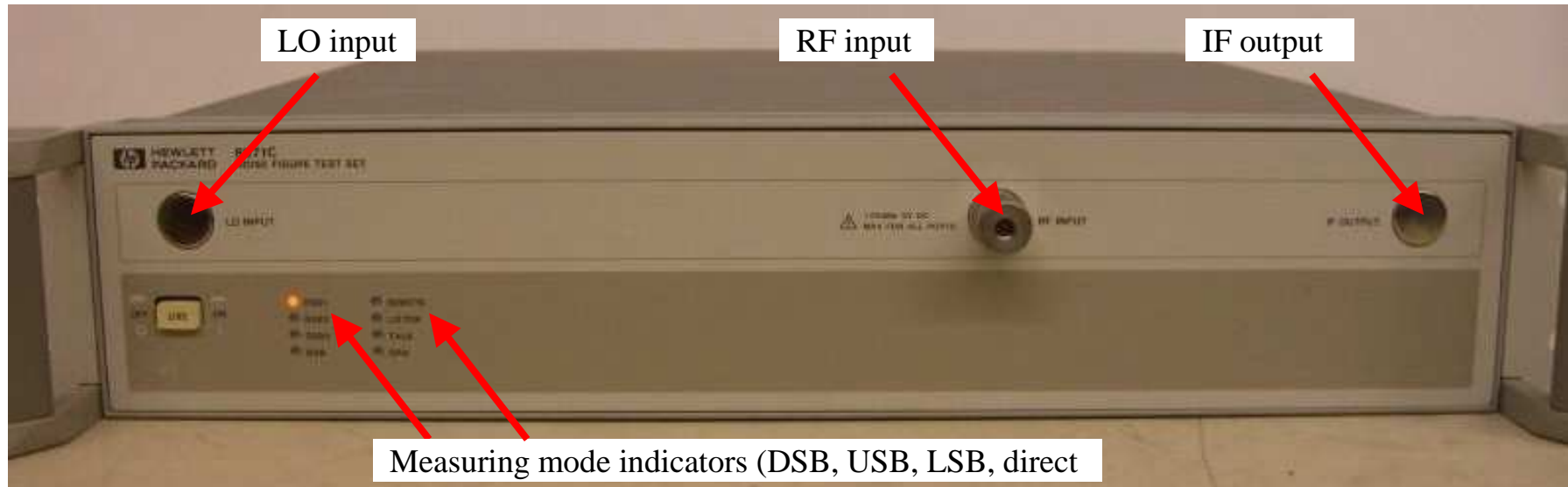

It's principally constituted by:

- a YIG following filter with GPIB tracking software
- an RF front-end broadband preamp
- a broadband mixer

Operation Modes:

- Band 1 - SSB1 (10-1600 MHz) using HP 8970b internal mode
- Band 2 - SSB2 (1601-2400 MHz, 700 MHz IF)
- Band 3 - SSB3 (2401-18000 MHz, 450 MHz IF)
- Band 4 - DSB (2401-18000 MHz, 10 MHz IF)

# The choice in the industrial world

Agilent HP 8971b (or c model) noise figure test-set

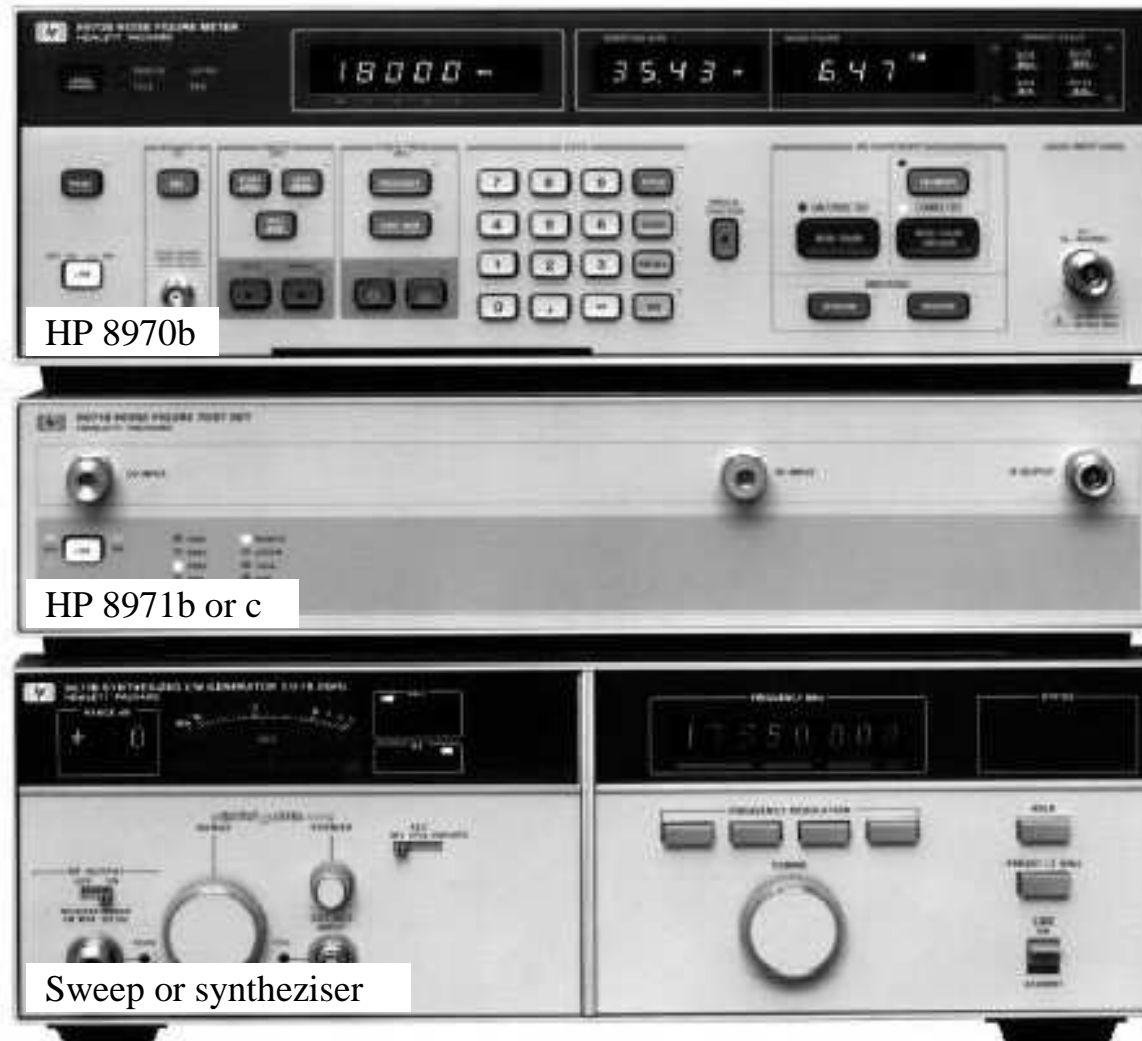

HP 8970T Noise Figure Measurement System (10MHz to 18 MHz).

# The choice in the industrial world

## Agilent HP 8971b (or c model) noise figure test-set

- Not supported by the HP 8970a model !
- In the figure, replace preamp + mixer by the NF test-set (+ additional Yig tracking filter)

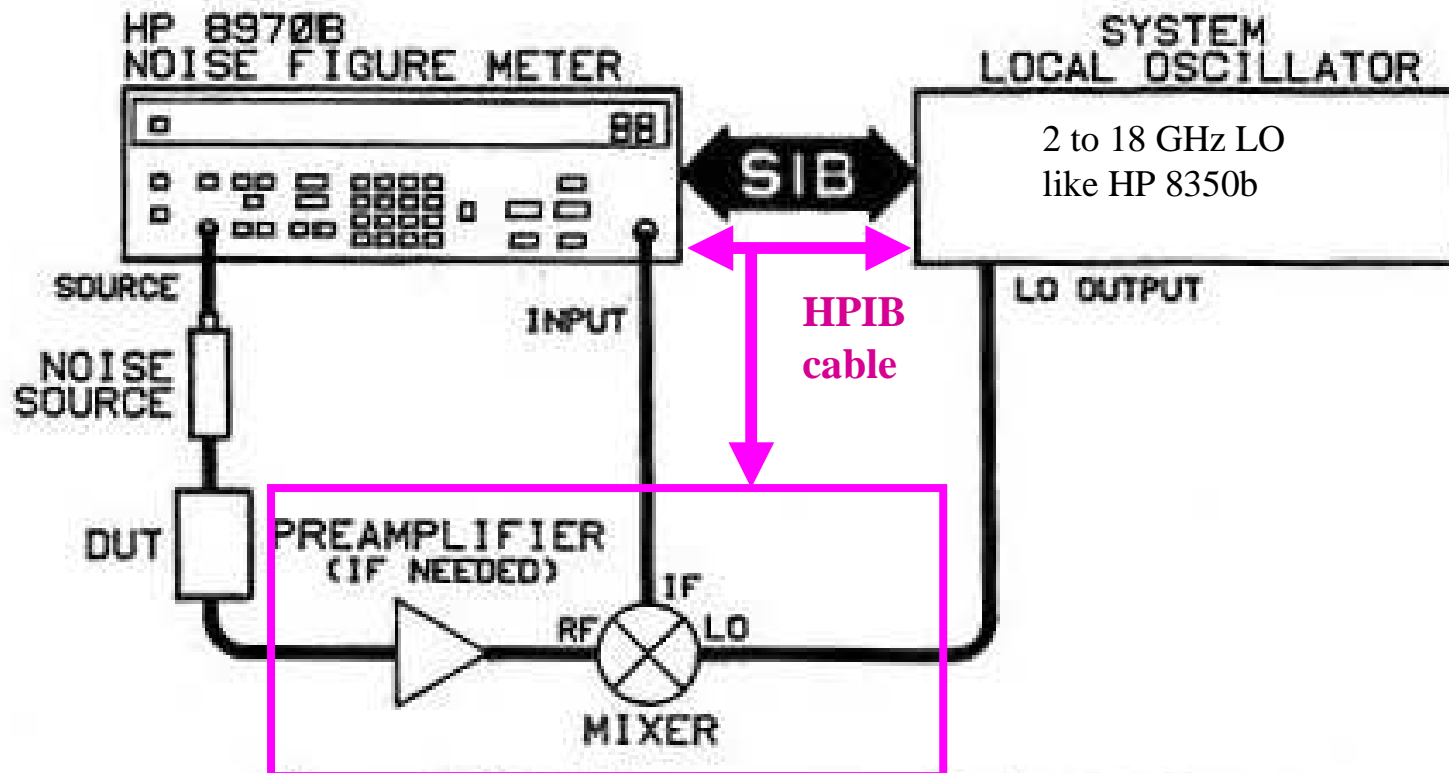

Figure 3-22. Measurement Mode 1.1 Setup

Configuration mode 1.1 choice = DSB mode with variable RF, external variable LO, fixed LO



# The choice in the industrial world

## Agilent HP 8971b (or c model) noise figure test-set

DSB or SSB mode

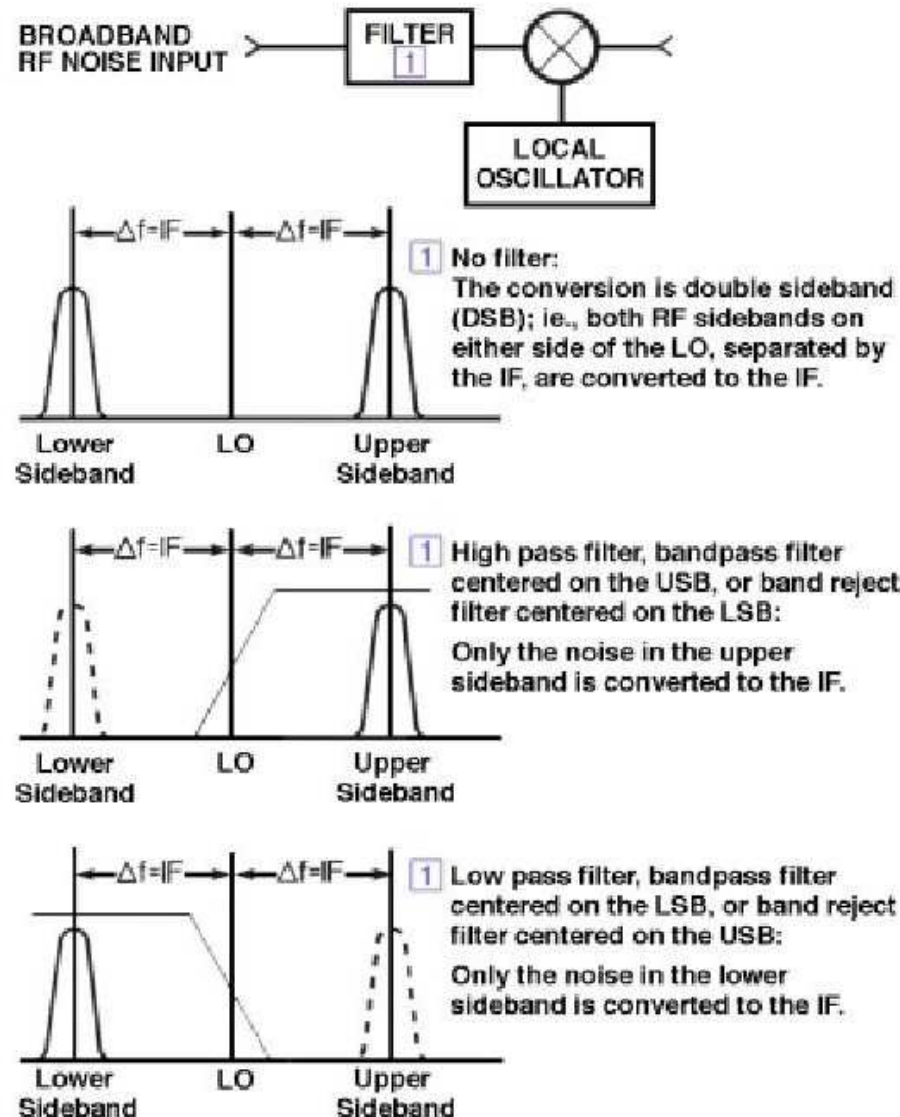

# The choice in the industrial world

## Agilent HP 8971b (or c model) noise figure test-set

- With relatively broadband amps, the DSB mode is preferred
- In this case the error between DSB and SSB mode is little, because IF signal of equal strengths
- No need of additional filter or preamplifier

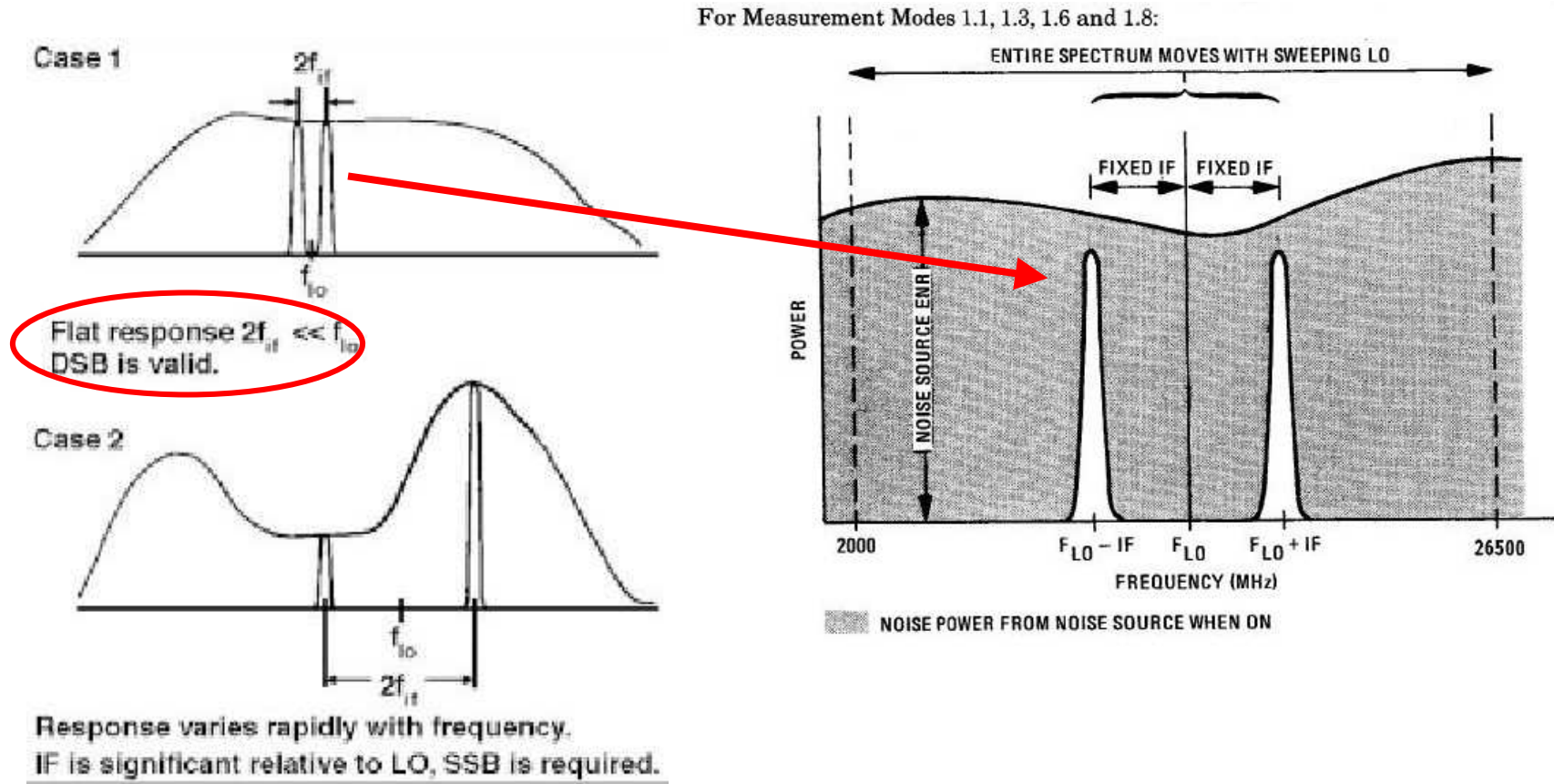

# The choice in the industry

## Eaton (Maury) MT 7550 series noise gain analyser frequency extender, up to 29 GHz

The choice of only DSB mode measurements possibility gives a design with :

- no internal tracking filter
- no HP/IB tracking requirement, only between analyser and sweep generator
- no need of additional filter, only a broadband preamplifier
- far cheaper to build and align

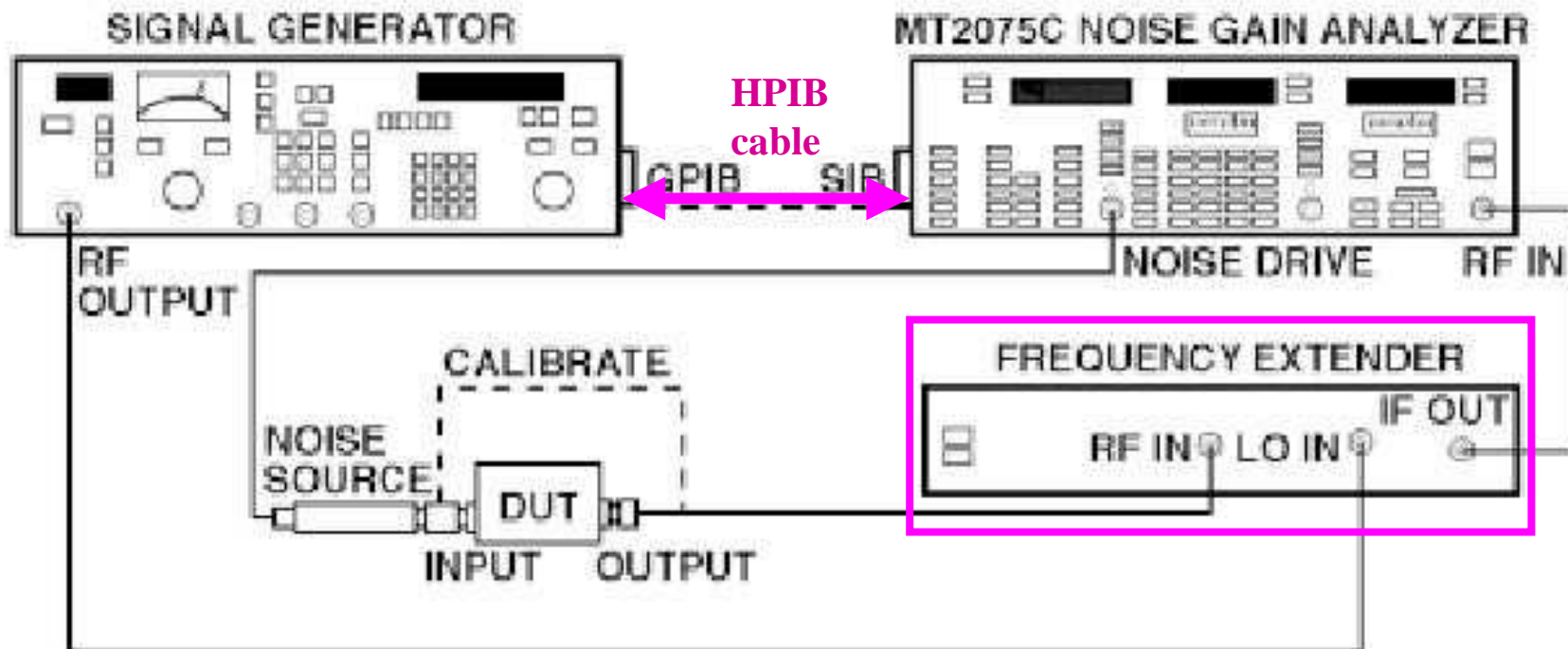

# The choice in the industry

## Eaton (Maury) MT 7550 series noise gain analyser frequency extender

3 models choice according to the frequency domain

Model	Frequency Range GHz	Conversion Mode
MT7550A	1.6 — 4.2	Single Sideband
MT7551B	1.8 — 18.0	Double Sideband
MT7552B	1.8 — 26.5	Double Sideband

→ no inside filter !

→ no inside filter !

Great advantage : full compatibility with :

- all Agilent/HP sweeps 9350a or b series - - or sweep synthesiser
- all Maury/Eaton or Agilent/HP noise/gain analyser

# The choice in the industry

## Comparison between Agilent/HP and Eaton/Maury designs

	HP test-set	Eaton extender
Compatibility	Only with HP 8970b version	<b>With all HP &amp; Eaton versions</b>
NF uncertainty at 2 GHz	Greater at low frequencies	Lower
DSB and SSB possibility	Yes	No
Price	« Expansive »	Far lower
2nd hand choice	Yes but expensive	Never found

# The choice in the industry

## Comparison between Agilent/HP and Eaton/Maury designs

NF uncertainties compared between both extension brands (Eaton point of view)

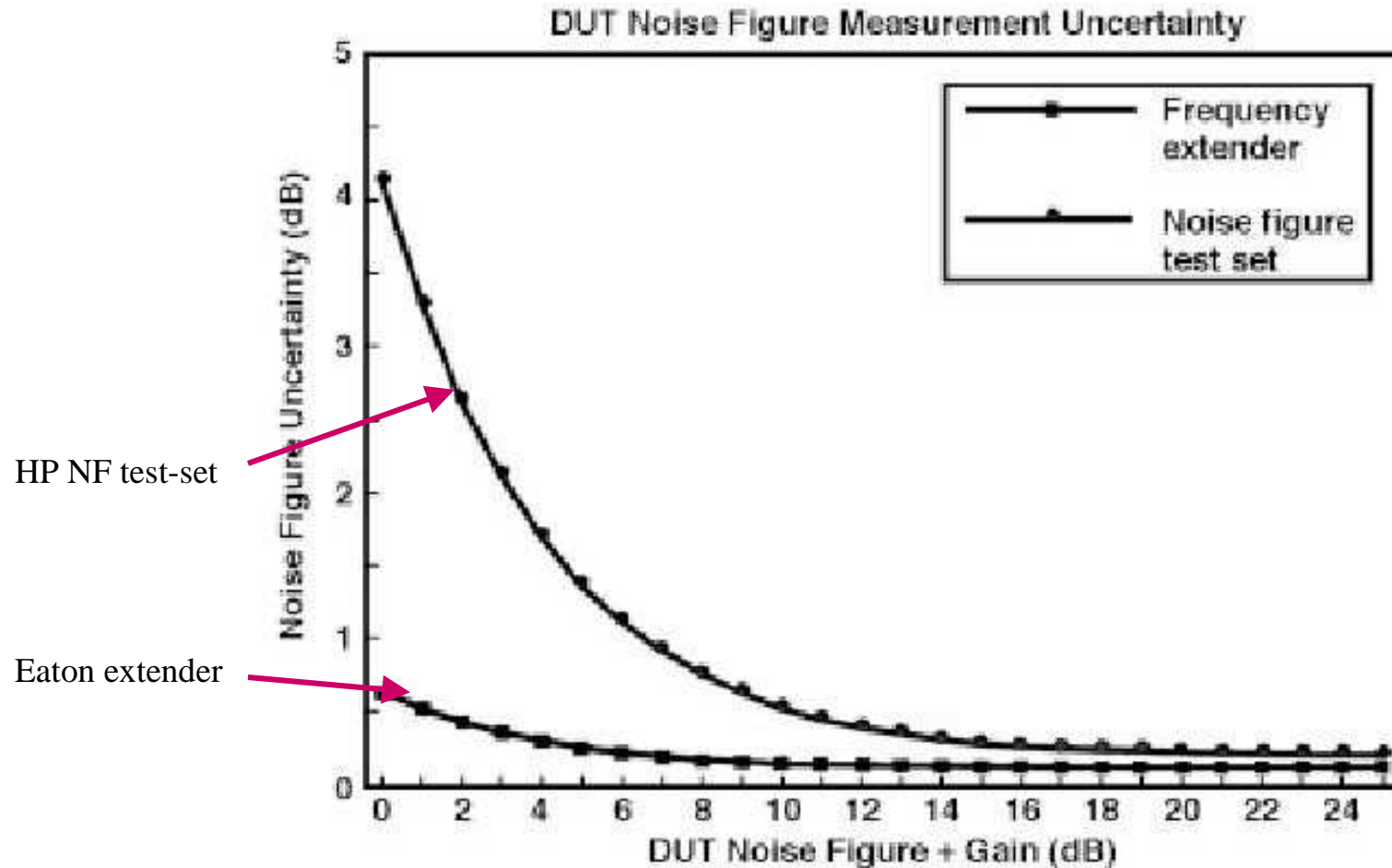

# The choice in the industry

## Comparison between Agilent/HP and Eaton/Maury designs

DSB and SSB measures comparisons, according to Eaton

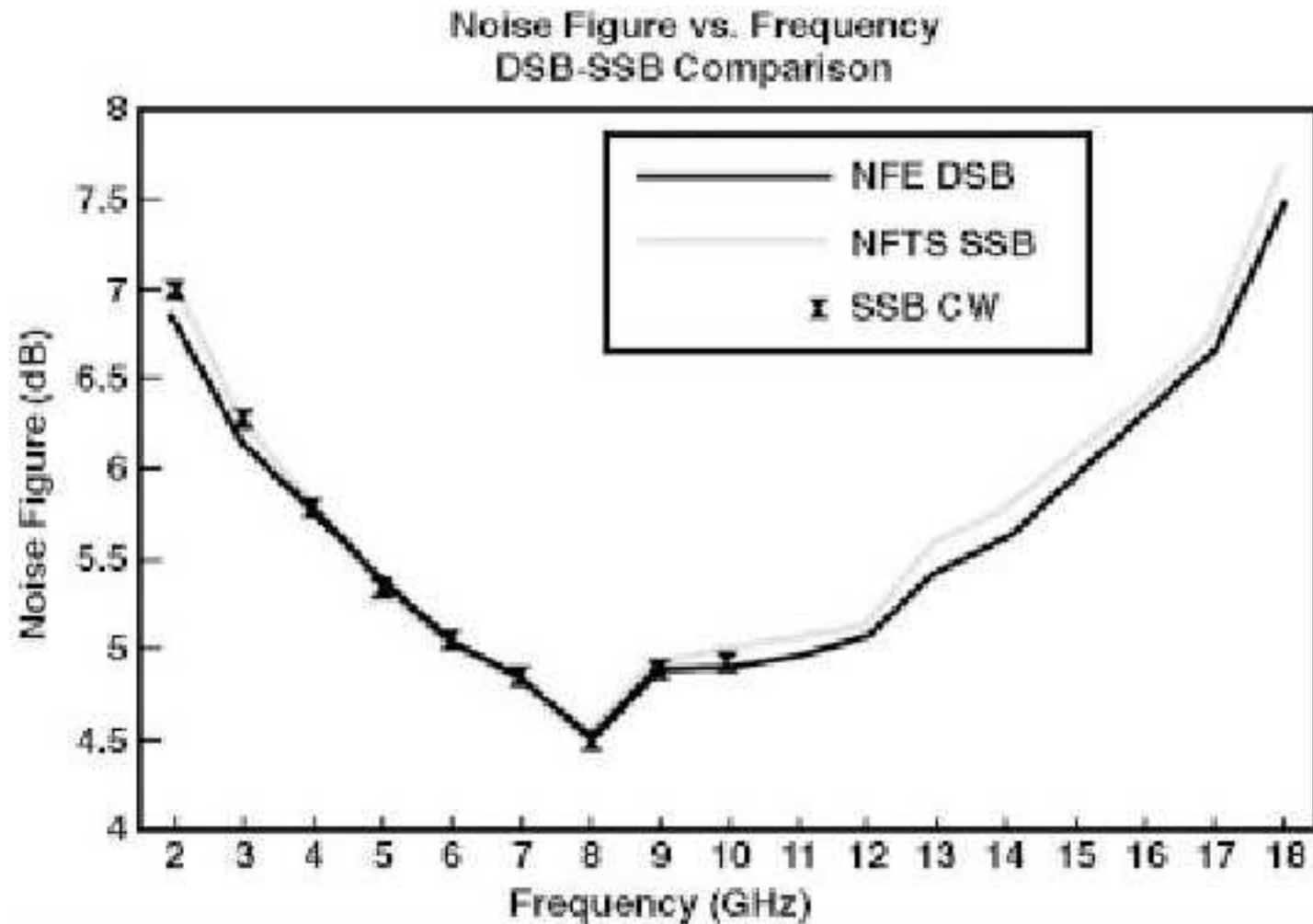

**2- Direct low-cost DSB measurements on preamplifiers with only an external RF mixer and a sweep generator**



# Measurements at $F > 2$ GHz with external mixer

**Target : maximum gain & NF stability after 0 calibration with**

- DSB option choice because microwave amps have a relatively broadband at high frequencies, in comparison of the IF frequency taken for the meas (like a 5.7 GHz preamp measured with a 70 MHz IF).
- **FIXED IF choice à 30 or 70 MHz** - - so both IFs will sure have exactly the same power
- Choice of a double or preferably triple balanced mixer
- Care taking of optimal (not maximal) LO injection power for minimal insertion loss, between +7 to +13 dBm
  
- Older analyser versions like the HP 8970a or the Eaton 2075a can be used !
- Older sweep versions like the HP 8350a can also be used (not only the b version like with the HP NF test-set) !

**Examples of typical balanced SMA mixers (all tested):**

Brand	Model	RF (GHz)	IF (GHz)	Balance	P LO opt (dBm)
Macom	MD-123	0.01-3	0.01-3	double	+10 to +15
W-J	M52C	2-18	0.1-4	triple	+10
W-J	M83C	1-18	0.03-5	triple	+13
W-J	M87C	0.5-19	0.03-5	triple	+13
Miteq	TB0218	2-18	0.5-8	triple	+10
Anaren	74129	5-18	DC-2.5	double	+12

W-J = Watkins Johnson

# Measurements at $F > 2$ GHz with external mixer

Measurement setup with a 2-18 GHz triple balanced mixer

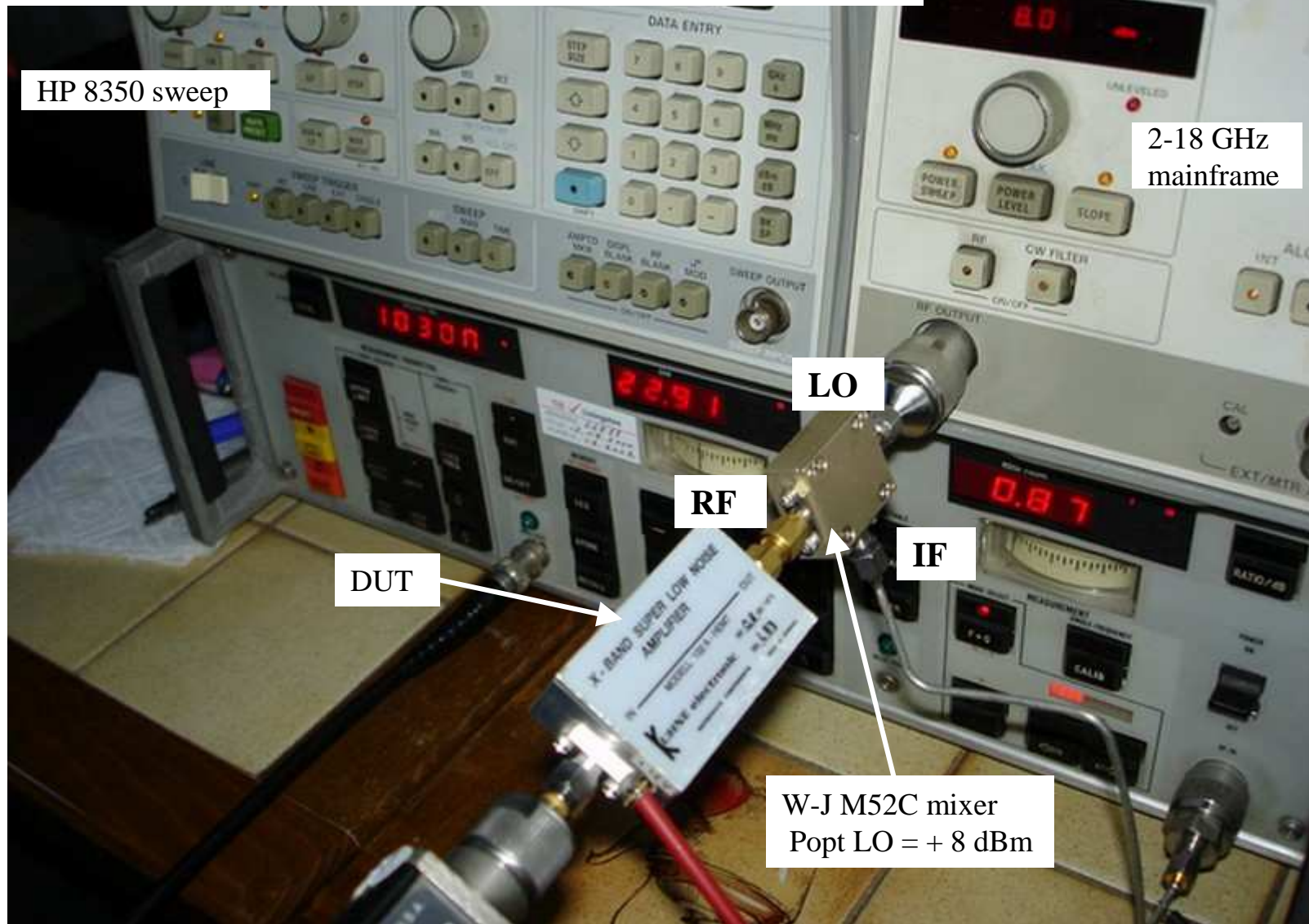

# Measurements at F>2 GHz with external mixer

## HPIB commands examples using either the HP or Eaton analyser

Gain/Nf measures in DSB with outside LO at frequencies > 2 GHz									
With HP 8970a analyser					With Eaton 2075 analyser				
HP 8970a master					Eaton 2075 master				
HPIB cable					HPIB cable				
HP 8350a ou b slave sweep default address 8					HP 8350a ou b slave sweep default address 8				
<b>HPIB analyser menu to enter</b>									
page 3-70	1,1	SP	LED Local Talk "on"	Var RF, ext LO, fixed IF	SP	1,2	Enter		
Start	6000	Enter		Start 6 GHz	Start	6000	Enter		
Stop	12000	Enter		Stop 12 GHz	Stop	12000	Enter		
Step size	100	Enter		Step size	Step size	100	Enter		
				= DSB	SP	2,0	Enter		
	41,0	SP		Drives the HP 8350a or b sweep	SP	47,3	Enter		
	4,1	SP		Takes the HP 8350a control	SP	40,2	Enter		
	3,0	SP	70	Fixed IF of 70 MHz	Shift	Start	70	Enter	
Sweep HP 8350	Pwr lvl	6	dBm	P LO = +6 dBm	Shift	↑ 6	Enter		
	19,1	SP		IF cal	SP	33,0	Enter		

# Measurements at F>2 GHz with external mixer

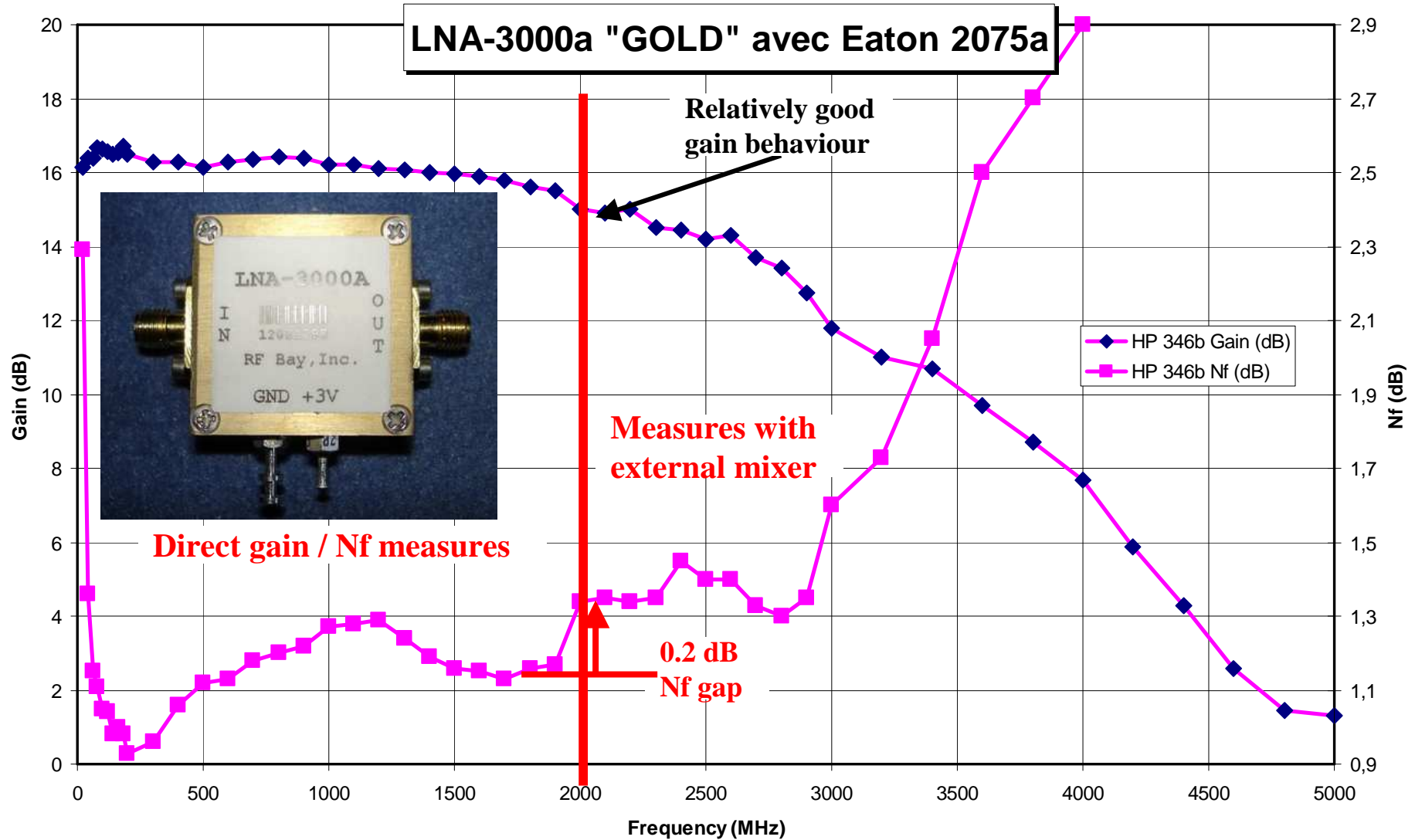

# Measurements at F>2 GHz with external mixer

Good and safe compartment on scalar analyser (S11 always positive)

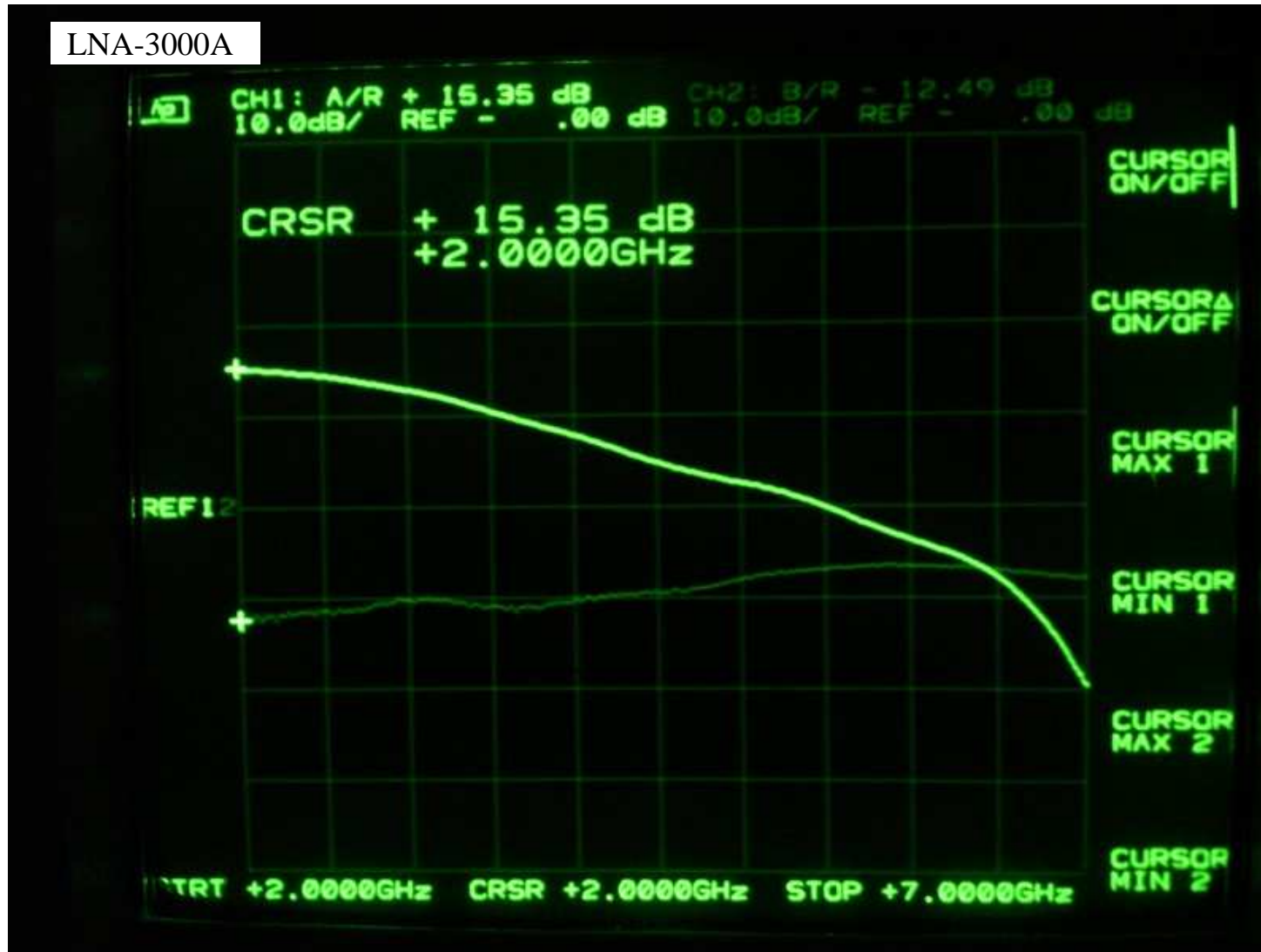

# Measurements at F>2 GHz with external mixer

## ENR value influence on precision measurements

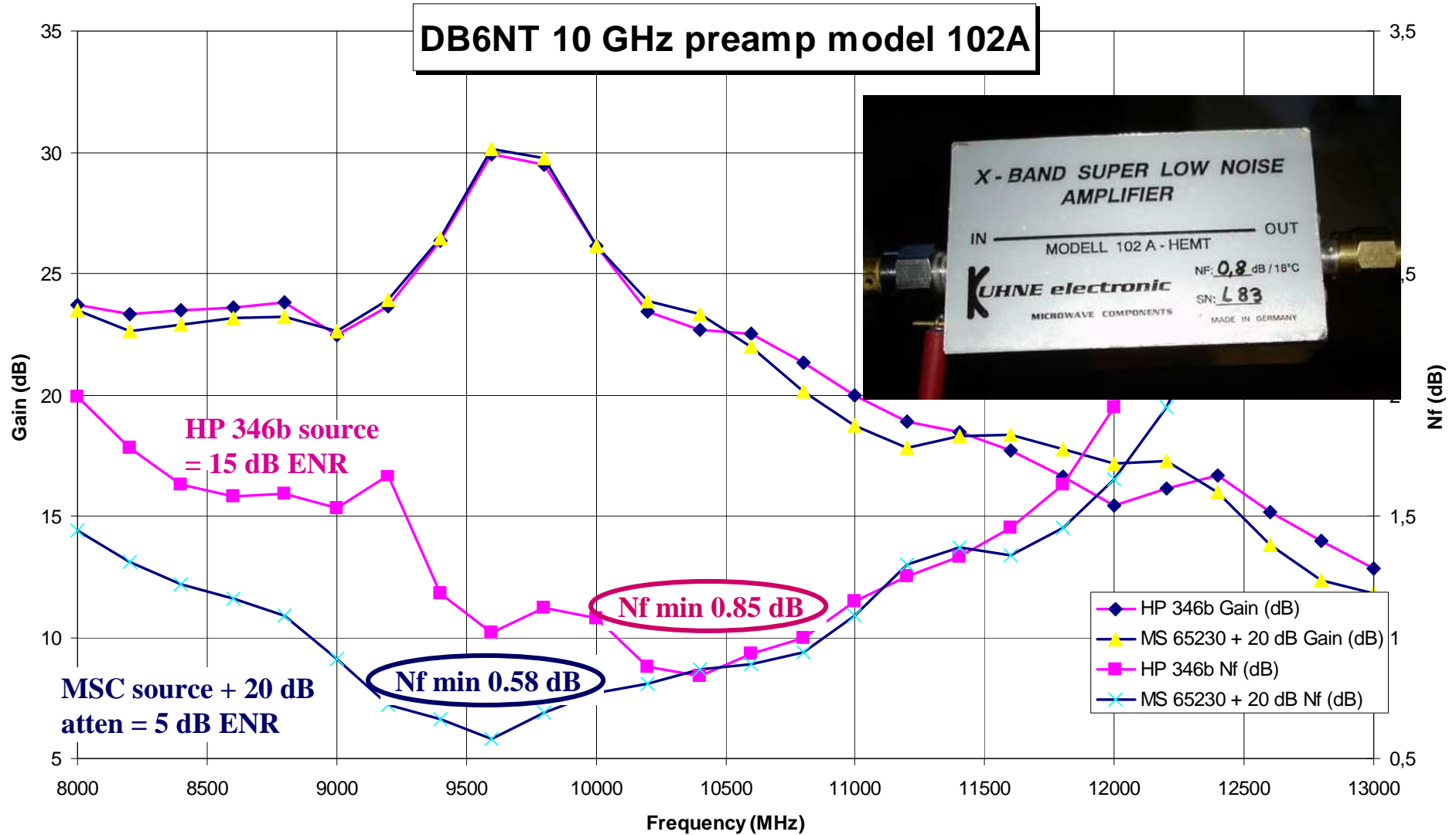

# Measurements at $F > 2$ GHz with external mixer

Good and safe compartment on scalar analyser (S11 always positive)



# Measurements at $F > 2$ GHz with external mixer

## Measurement of a 50 dB gain broadband amplifier

- Because of its too high measured gain, a 20 dB attenuator is put at its outside.
- So an additional 20 dB **loss after DUT** must be entered into the analyser menu.

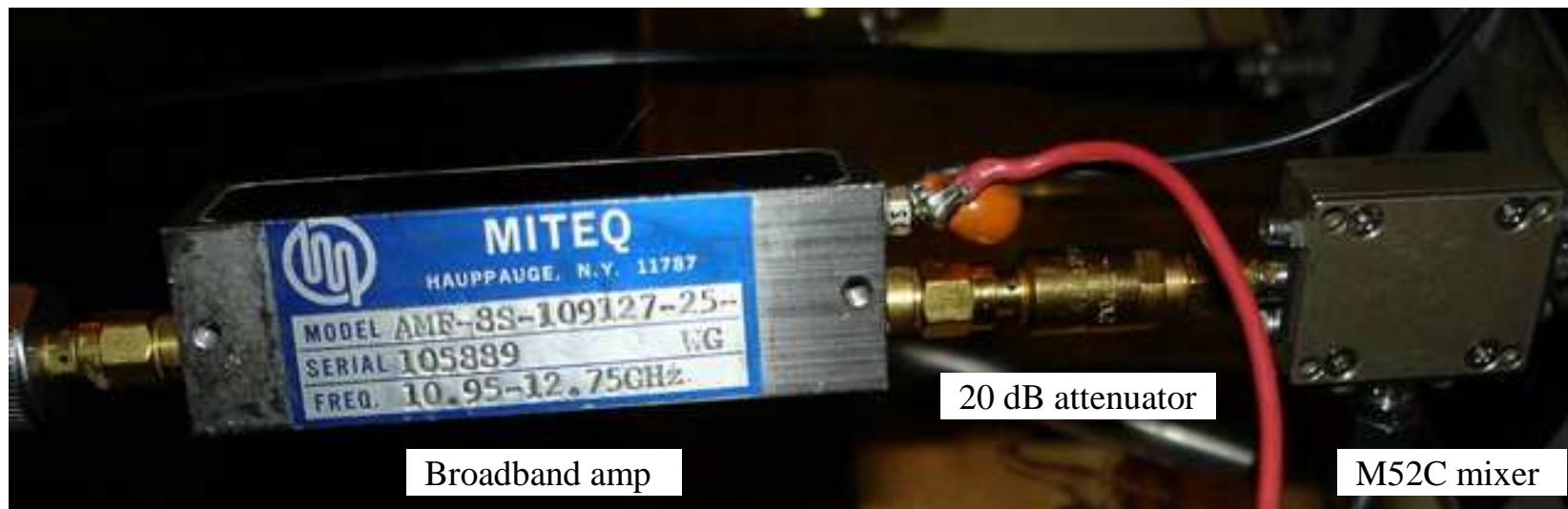



# Measurements at F>2 GHz with external mixer

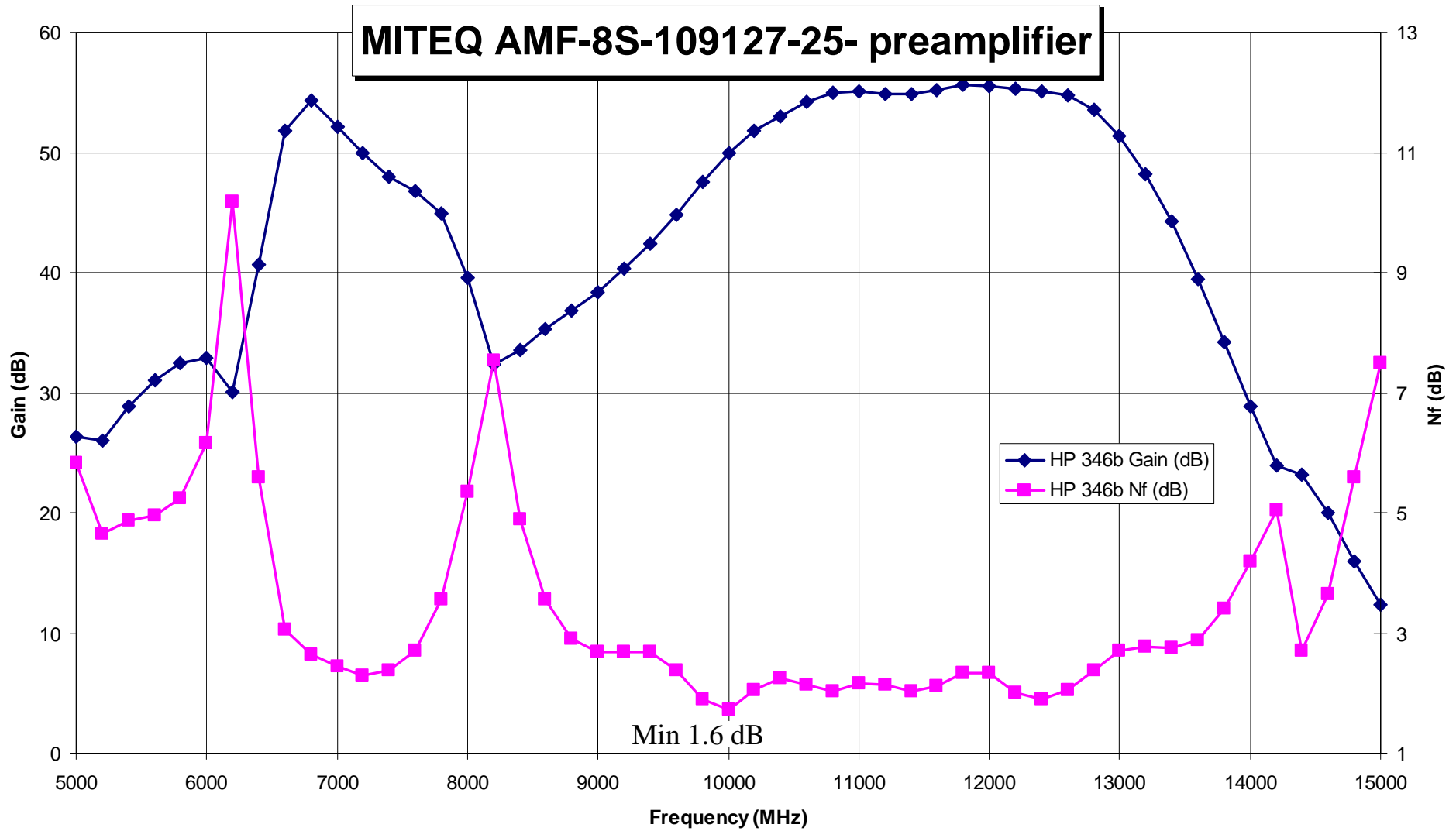

# Measurements at $F > 2$ GHz with external mixer

Comportment on scalar analyser, especially for its S11 curve

Miteq AMF-8S-109127-25 preamplifier

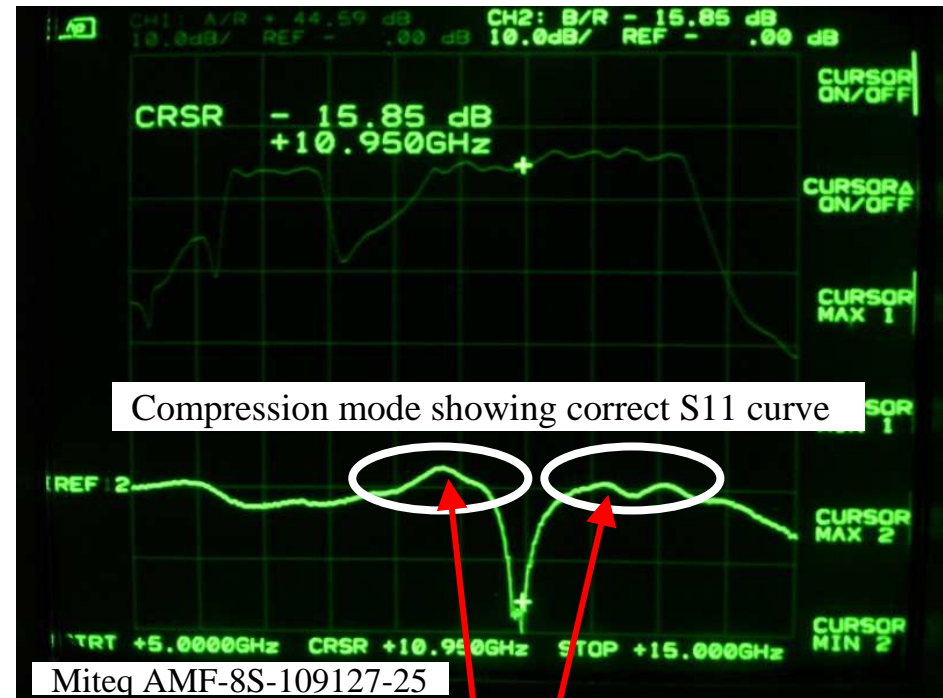
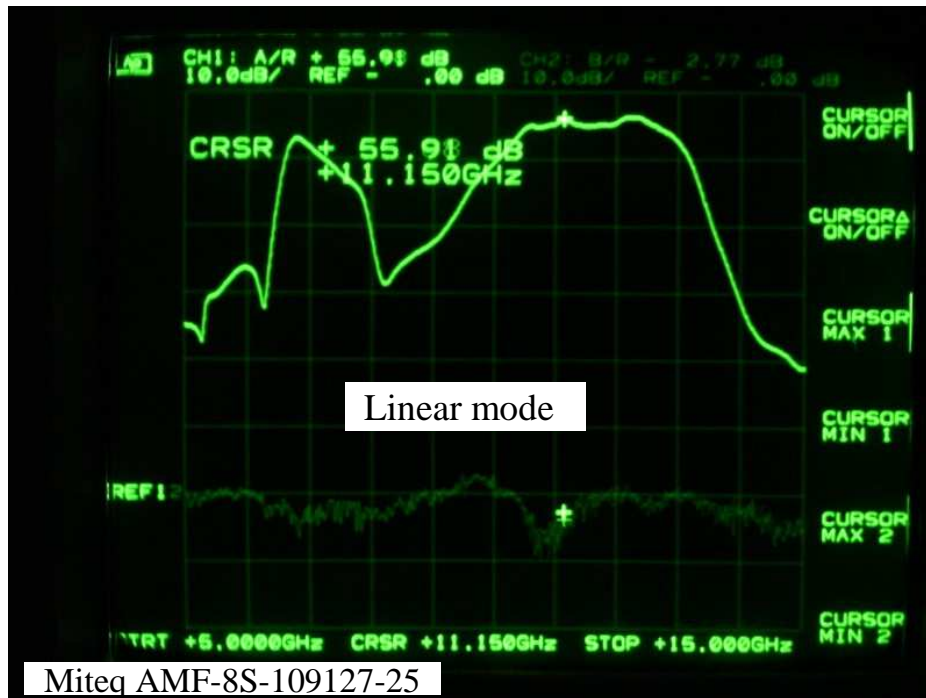

S11 slightly positive and suspicious !!  
Calibrating or oscillation beginning problems ?

**GAIN : compare both values obtained with gain/NF and scalar analyser !!**

## **3- X, Y and Z outputs on an oscilloscope**

# X, Y and Z outputs on an oscilloscope

## One point NF measure or broadband gain + NF curves ?

- Doing only NF measurements at one fixed point in a ham band has **NO SENSE** !
- The great gain obtained on our masthead preamps can conduct to auto-oscillation
- Example: on a scalar analyser, look the S11 at its max gain ! You'll be astonished to see how it can approach the zero value, and in certain cases, be a little positive !!! That becomes easily an oscillator !
- If the temperature goes about 40°C down (from summer to winter), many masthead preamps are very easy oscillating !!!
- In order to feel how your (pre)amplifier is working, the only way to know it is to visualise in BROADBAND operation the regularity of both GAIN AND NF curves (french word = monotone) !!!
- Both HP and Eaton analysers have the three X, Y and Z output possibility to visualise this.

# X, Y and Z outputs on an oscilloscope

Philips PM 3209 using the X defl possibility on its time base

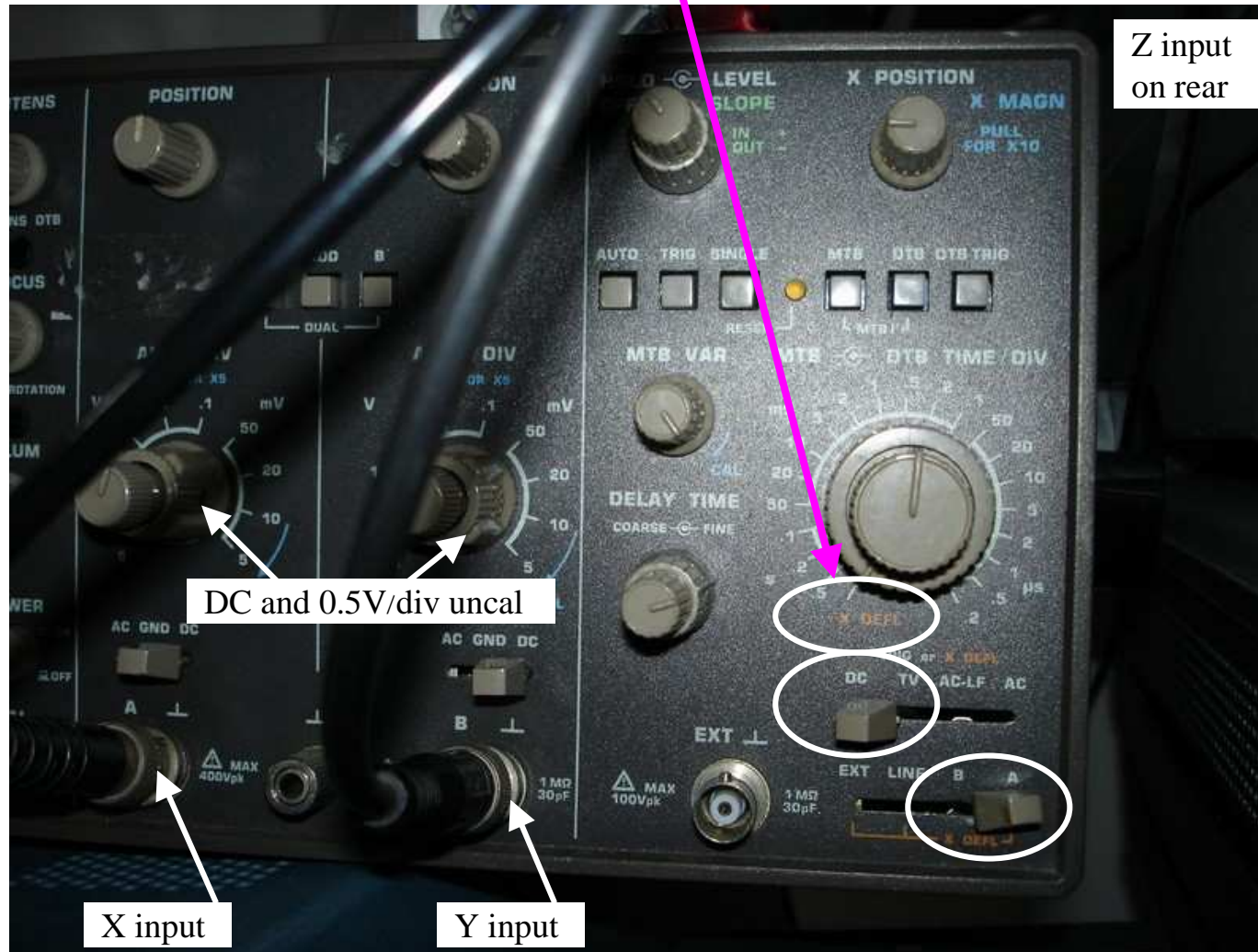

# X, Y and Z outputs on an oscilloscope

Philips PM 3209 using the X defl possibility on its time base

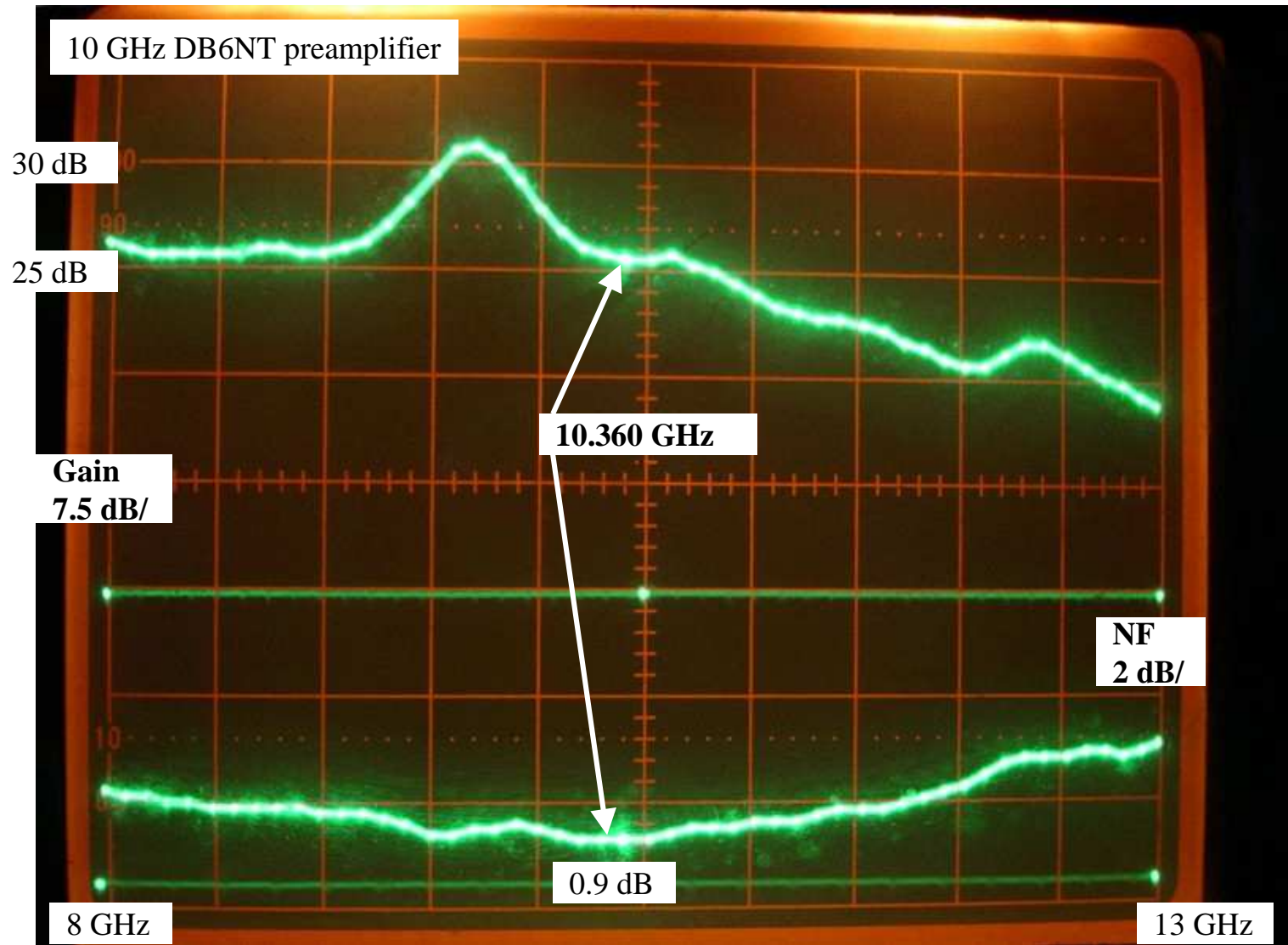

# X, Y and Z outputs on an oscilloscope

Philips PM 3209 using the X defl possibility on its time base

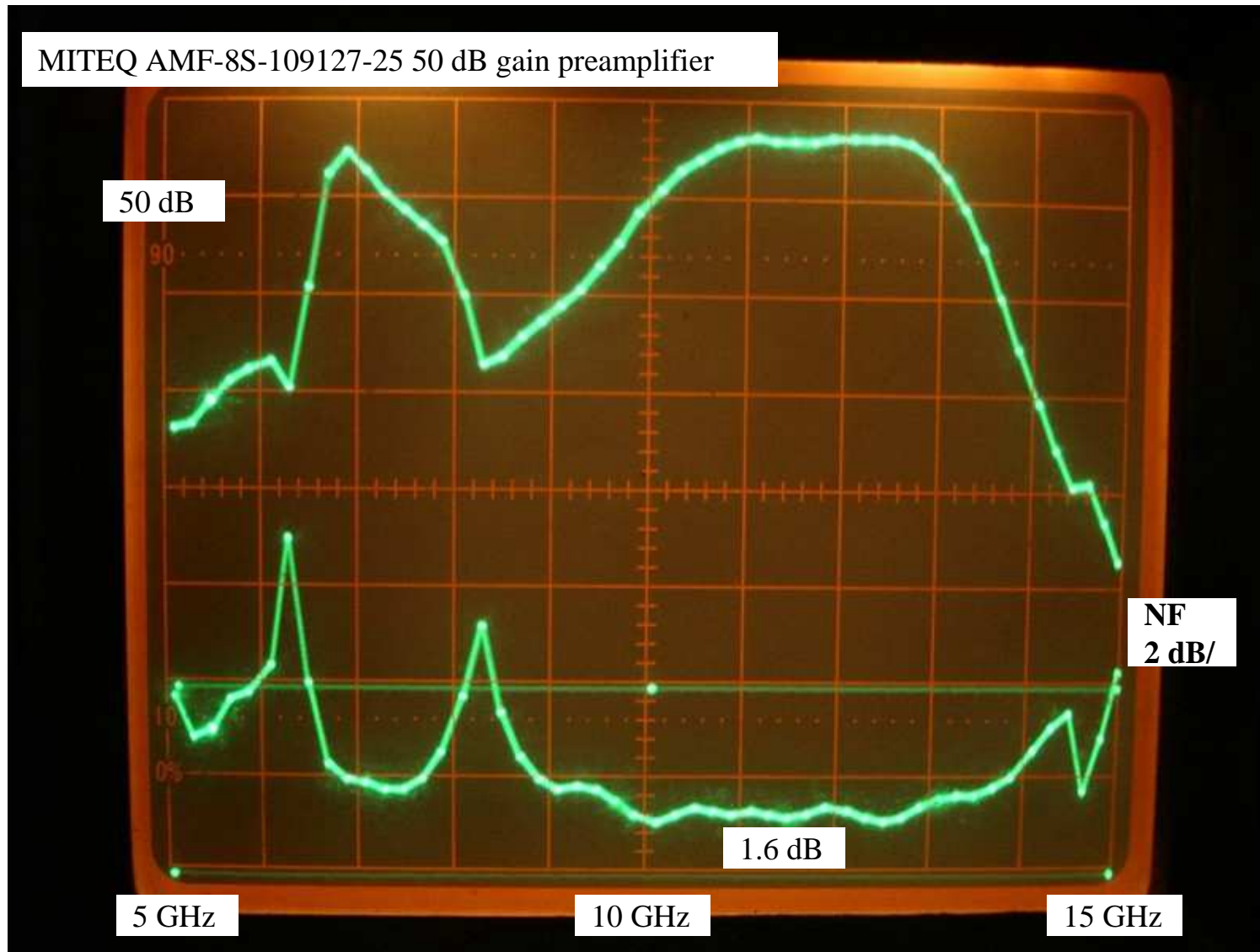

# X, Y and Z outputs on an oscilloscope

## Tektronix 7603 using time-base and Y amplifier plugins

Its 7B80 time-base unit is replaced by a 2nd conventional Y amplifier 7A16 or 7A18 module (thanks to F6BSW for this trick)

**Substitution only possible with oscilloscope mainframes accepting plugins !**

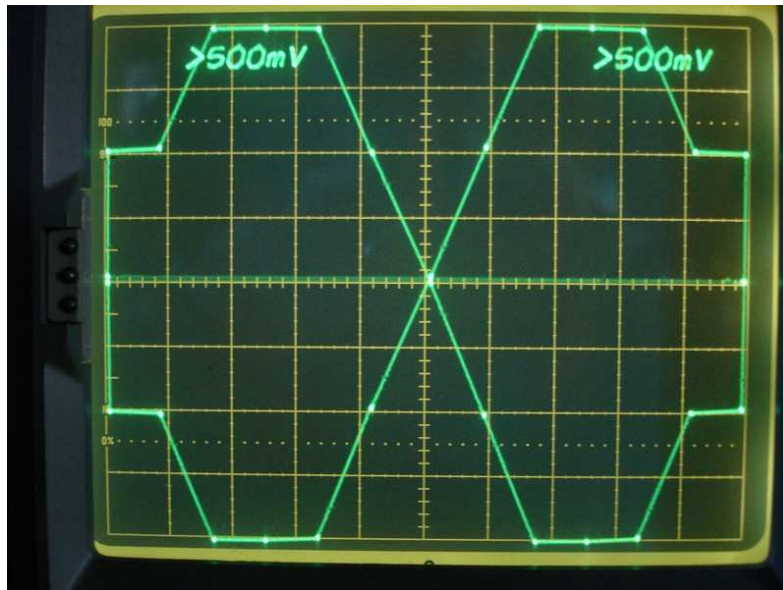

Initial test pattern obtained with :  
- SP 7.2 « Enter » on Eaton 2075  
- 7.1 SP on HP 8970

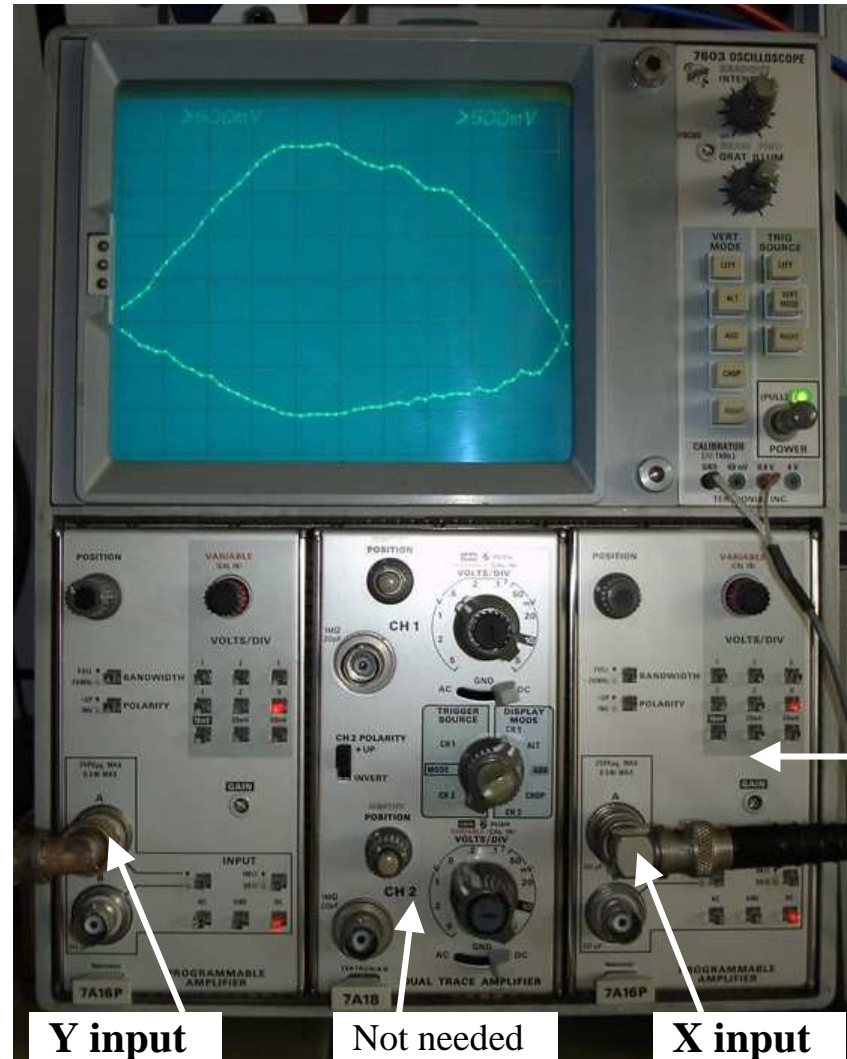

2nd Y amp instead of time-base



# X, Y and Z outputs on an oscilloscope

Tektronix 7603 using time-base and Y amplifier plugins

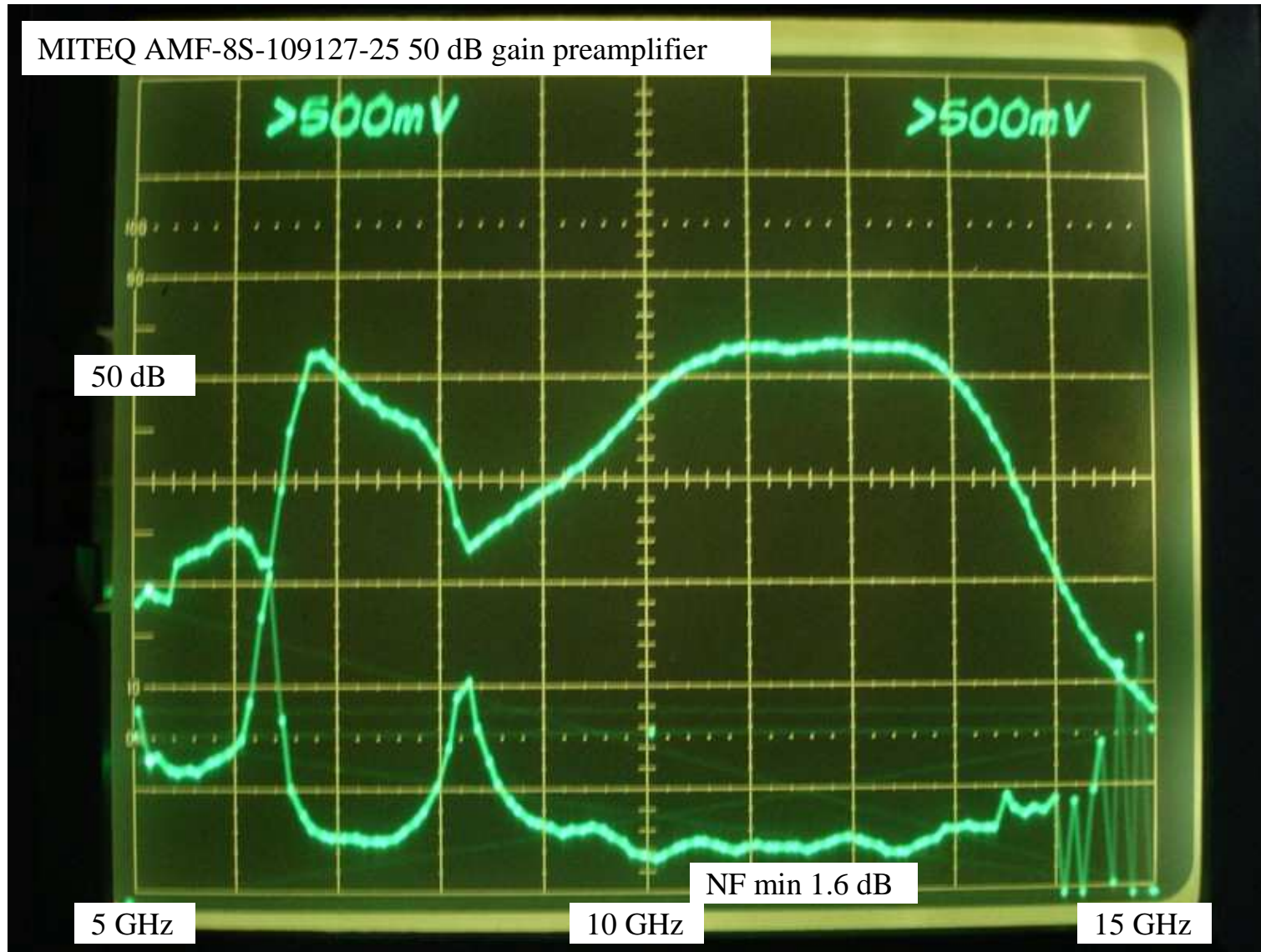

# X, Y and Z outputs on an oscilloscope

Tektronix 7603 using time-base and Y amplifier plugins

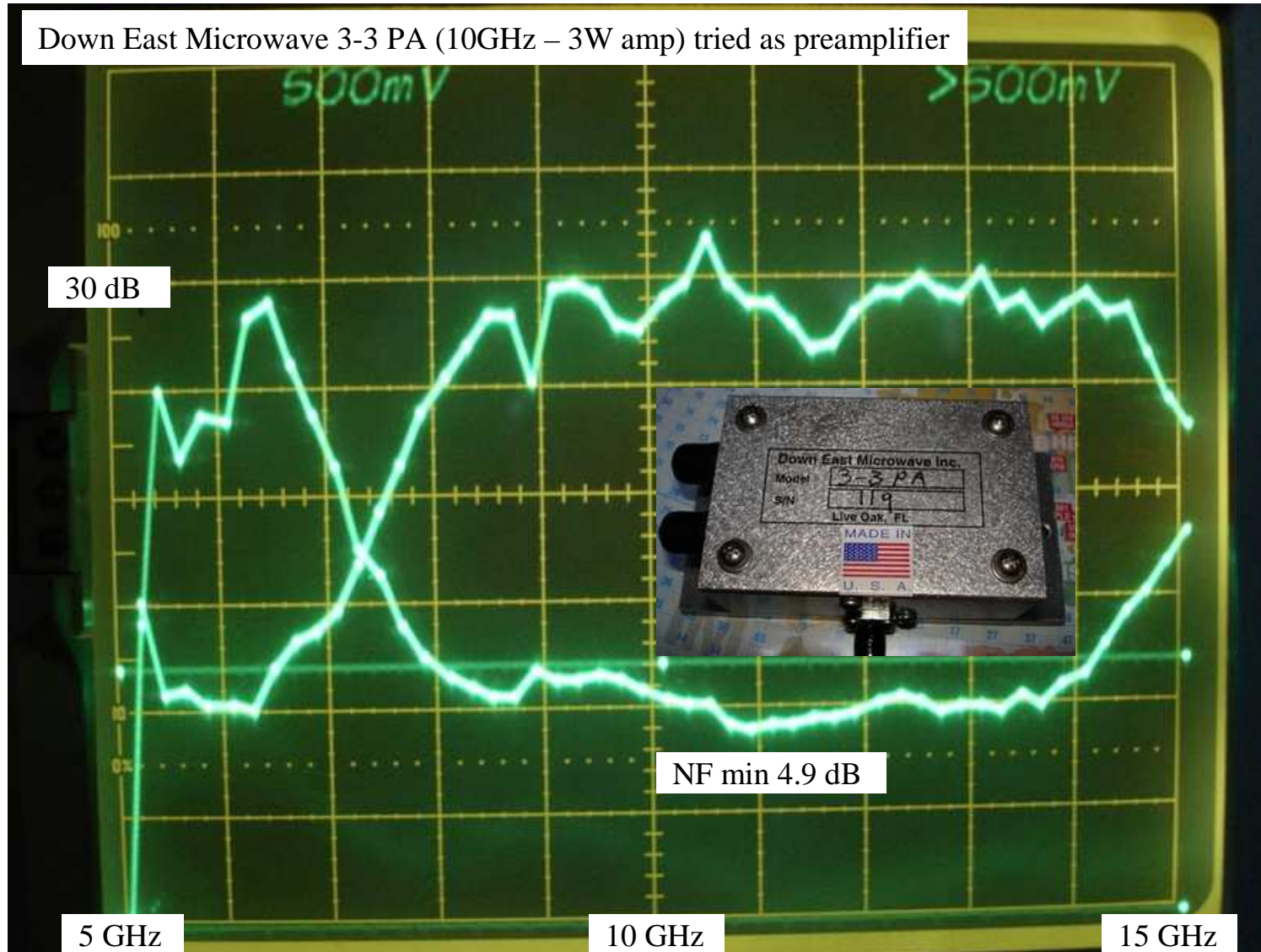

## **4- Calibration of unknown noise sources from 2 to 18 GHz**

# Unknown source calibration

Every 25, 15 or 6 dB noise source can be calibrated with a previous « gold » reference

F5DQK		longue	F5DQK		courte	F1PDX	
AILTECH		7616	AILTECH		7616	MSC	
S/N		3710	S/N		3300	MS 65230	
21/01/2009			21/01/2009			21/01/2009	
F (MHz)	ENR (dB)	F (MHz)	ENR (dB)	F (MHz)	ENR (dB)	F (MHz)	ENR (dB)
10	6,65	10	14,7	10	24,19		
30	12,64	30	16,14	30	25,38		
50	13,94	50	15,59	50	24,83		
70	14,47	70	15,69	70	24,98		
110	14,78	110	15,83	110	25,08		
150	14,93	150	16,13	150	25,29		
430	15,13	430	16,13	430	25,51		
1000	15,28	1000	16,18	1000	25,52		
1300	15,32	1300	16,23	1300	25,39		
1500	15,34	1500	16,14	1500	25,3		
1900	15,49	1900	15,84	1900	25,28		
2000	15,16	2000	15,44	2000	24,98		
2300	15,09	2300	15,49	2300	23,79		
3000	15,07	3000	15,12	3000	24,58		
4000	14,72	4000	15,32	4000	24,46		
5000	14,61	5000	15,51	5000	24,72		
5600	14,29	5600	15,29	5600	24,33		
6000	14,36	6000	15,31	6000	24,47		
7000	14,7	7000	15,52	7000	25,04		
8000	14,68	8000	15,28	8000	24,91		
9000	14,48	9000	15,28	9000	24,76		
10000	15,43	10000	15,53	10000	24,7		
10360	15,58	10360	15,23	10360	24,42		
11000	15,48	11000	15,13	11000	23,88		
12000	15,05	12000	14,9	12000	23,97		
13000	15,78	13000	15,23	13000	24,06		
14000	14,75	14000	13,75	14000	23,3		
15000	14,93	15000	15,58	15000	23,18		
16000	14,31	16000	13,31	16000	23,46		
17000	14,44	17000	14,39	17000	24,72		

**DIRECTLY !**

**EXTERNAL MIXER !**

Multipoint calibration also at every GHz

Calibration of a totally unknown MSC source

## **5- Conclusion**

# Conclusion

- For conventional ham purposes (large band microwave preamps and also transverter), DSB measures are giving largely enough accuracy
- According to the band of interest, the mixer choice must be carefully done
- The LO power injection must be chosen for minimal conversion loss
- No need of extra expansive NF test-set or frequency extender
- No need of an additional broadband amplifier
- Both oscilloscope gain and NF traces are useful to immediately thumb-up oscillating problems
- A complementary scalar analysis can confirm the linear gain and may also thumb-up oscillations beginning problems
- And in opposite way, a single gain / NF measure at only ONE frequency has **absolutely NO SENSE !**
- 2 to 18 GHz calibration of unknown noise sources can be easily achieved

*Special thanks to F6FTN, F5BQP, F6BSW, F6DPH, F6AJW and F1PDX for their very useful help*