

Transverter 2302 / 144 MHz WA8NLC

Ancêtre du transverter DEMI_2304 actuel

Seule documentation accessible sur www.downeastmicrowave.com

Propriétaire actuel Marc F8DLS



Release 4
last edition : sept 2014!

Avant-propos

- Les mesures en Rx donnant une valeur de bruit très élevée pour l'époque, il a été décidé d'en étudier la possibilité éventuelle d'amélioration
- Avec malheureusement aucune documentation accompagnatrice, une étude complète de reverse engineering s'est donc imposée d'office
- Pour moderniser la partie Rx et améliorer sa figure de bruit, N2CEI de DEMI propose une modification Rx à l'aide du circuit Avago MGA-86576, en vue de ramener sa Nf aux environs de 1.5 dB

C'est donc ce but d'amélioration Rx que je me suis alors fixé !

Plan

- 1- Spécifications usine, version différente antérieure et réalité mesurée
- 2- Schémas WA8NLC puis DEMI
- 3- Prise en main
- 4- Modification Rx préconisée par DEMI, en vue d'obtention de meilleur Nf
- 5- Platine de commutation PTT et « mise en compatibilité DB6NT »
- 6- Améliorations apportées
- 7- Conclusion, remerciements
- 8- Annexe 1 pour Hailsat : substitution de l'oscillateur local initial par un PLL DF9NP
- 9- Annexe 2 : simulation/ mesures sur les filtres Hairpin avec le logiciel Quickfilter**

1- Spécifications

Specs usine sur Internet (tout du moins version plus récente) !



DEM Part Number 2304-144 _____
 13 cm Transverter Serial Number _____

??

Specifications	
Frequency after 10 Min warm up:	2304.100 MHz. = 144. _____
Noise Figure and Gain:	1.9 dB nom. > 17 dB Gain
Power Out:	20 mW 1 W Other _____
DC Power Requirement:	10 - 15.5 VDC @ 1 Amp
IF Option:	Common or Split
IF Drive Level Requirement Option:	10 mW 1-10W Other _____
Keying Option:	PTT - to ground TTL - Positive Voltage
Aux. Connection Output Option:	Ground on TX + Voltage on TX _____
TR Switch Option:	None Installed Supplied

Attention :

- Version étudiée pour la bande US 2304 (et non 2320) MHz
 - Specs indiquée ne concernant que la ou les versions suivantes commercialisées par DEMI !!
- L'exemplaire en main est de fabrication largement antérieure !*

Mesures effectuées à réception sous 2320 MHz

Version WA8NLC en possession :

- Mesures Tx : Pout QRP uniquement +12 dBm
- Mesures Rx : Nf énorme
(loin des 1.5dB de l'actuelle version DEMI)



I_{Rx} = 380mA



I_{Tx} = 480mA

2- Schémas DEMI

- Article originel WA8NLC (ARRL 1996, 2nd printing)
- Réalisation DEMI plus récente

Article de WA8NLC 1/2

A No-Tune Transverter for 2304 MHz

By Jim Davey, WA8NLC
 4664 Jefferson Township Place
 Marietta, GA 30066
 (From December 1992 QST)

Introduction

The circuit, layout and performance of the 2304-MHz transverter are similar to those of the 3456-MHz design described in the article that follows this one. It has the following features:

- 10-mW transmit output
- Receiver noise figure of 3.5-4.0 dB
- Same 2-meter IF requirements (1-mW drive level)
- Same size circuit board
- Same no-tune local oscillator
- Even easier to assemble than the 3456-MHz version

For construction details and background information, refer to the 3456-MHz article. Only the major features of the 2304-MHz transverter are covered in this article. A preliminary version of this transverter was described in *Proceedings of Microwave Update '89*.

Construction

The entire transverter can be assembled in a few hours, including the box. The brass-box type of enclosure is recommended for mechanical and electrical bonding of the connectors. A cover is optional. The 2304 transverter is indifferent to the presence of a cover. A few builders of the 3456-MHz transverter, however, have noticed increased spurious outputs



Fig 1—Schematic of the 2304-MHz transverter. See the text for parts sources. When building this transverter, follow good microwave construction techniques, as detailed in the 3456-MHz transverter article that follows this one. The Avantek MSA-0185 is equivalent to the Mini-Circuits MAR-1; the MSA-0685 is equivalent to the MAR-6, etc. (Lead labeling varies, however; follow the manufacturer's instructions.) Bias-resistor values are given for 13.6-V operation. All capacitors in the 2304-MHz signal path are 50- or 100-mil ceramic chips, except for the 0.01- μ F coupling capacitors at the first IF input and output. Here, use ceramic discs, encapsulated chips or other low-loss capacitors. Use 1/4-W carbon-composition or film resistors.

- D1, D2—Hewlett-Packard HSMS-2822 surface-mount diode pair.
 D3—Hewlett-Packard 5082-2835 Schottky diode.
 FL1-FL6—Etched band-pass filter.
 L1—4 turns #28 enameled wire, 0.075 in. ID,

- closewound.
 U1, U2—Avantek MSA-0685 or Mini-Circuits MAR-6.
 U3, U4—Avantek MSA-0185 or Mini-Circuits MAR-1.
 U5, U7—Avantek MSA-0885 or Mini-Circuits MAR-8.
 U6—Avantek MSA-0385 or Mini-Circuits MAR-3.

of the transmitter with a cover in place. When mounting components, keep the bias resistors flat against the board and away from the filter elements. Wrap a small piece of copper foil through the ground holes for the bypass capacitors, under each MMIC and at the ground end of the LO multiplier diode. I used

SMA connectors for the 2304-MHz ports, but BNC connectors would be acceptable at this frequency.

As before, no matching is done at the IF ports. This has not been a problem, except if you want to measure the noise figure of the receiver. I have noticed that newer noise-figure

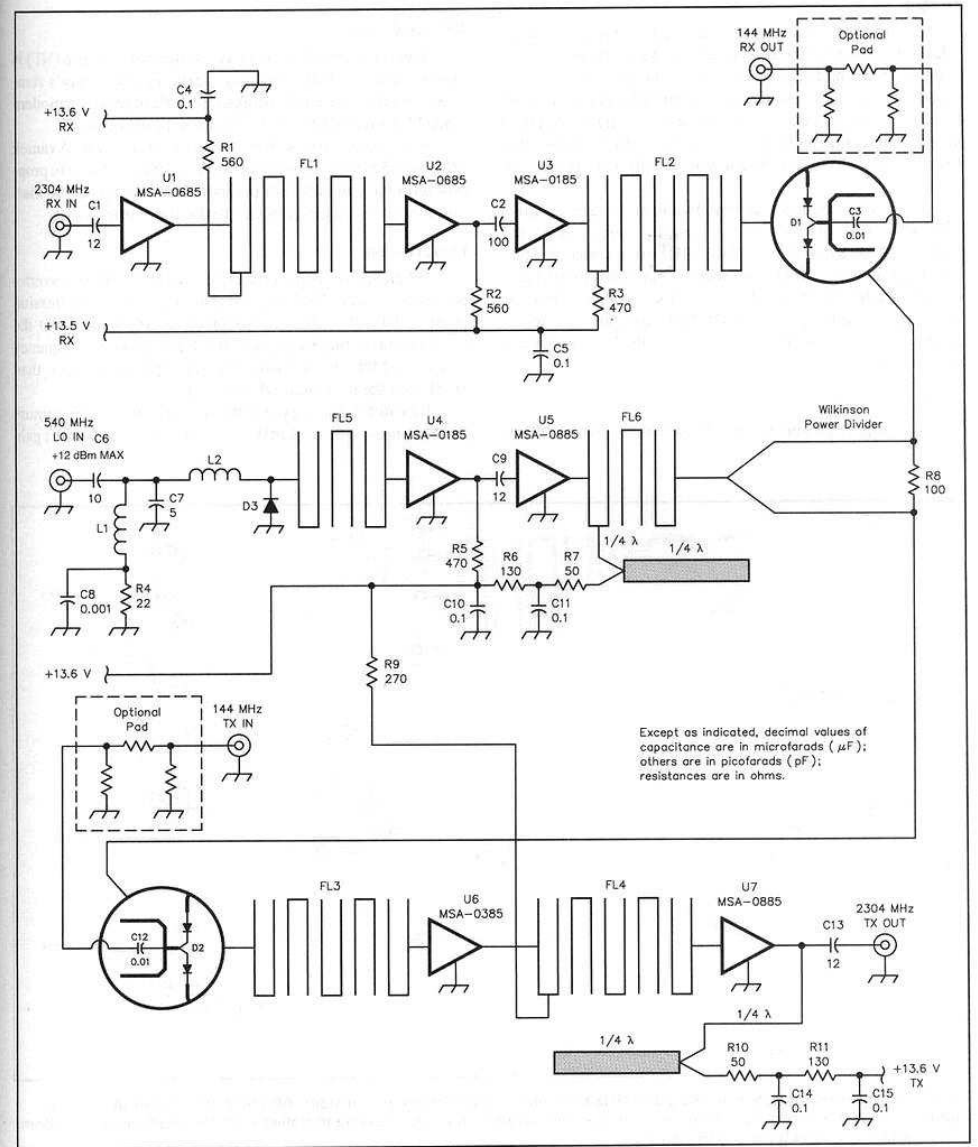

meters, like the HP 8970, have a problem with this arrangement due to the presence of other signals at the IF port, presumably the LO. If you want to check the noise figure, first run the receiver IF through a 2-meter converter to a lower IF, such as 28 MHz. When this is done, the problem with the test equipment should disappear.

Design

The transverter, shown schematically in Fig 1, is built on 0.032-in. woven Teflon board material with a dielectric constant of 2.5 and half-ounce copper foil. The key to the circuit's simplicity lies in the printed microstrip third- and fifth-order Chebyshev band-pass filters. These filters have excellent stopband rejection and low insertion loss. Midband insertion loss is just 2.1 dB, thanks to a low-loss Teflon PC-board substrate.

The center frequency and bandwidth of the receive filters were chosen to also allow receive-only operation on the OSCAR Mode S downlink at 2401 MHz using a 564.25-MHz LO. The transmitter-filter bandwidth is narrower, to help suppress unwanted mixing products. The transverter shouldn't be used for transmitting above 2325 MHz without an external cavity or interdigital filter that attenuates the LO signal by at least 10 dB.

Transmit Converter

Transmitter power output is 10 to 20 mW (10 to 13 dBm)

and varies slightly with component variations in the Avantek MSA-0885 MMIC output stage. Although more power would help balance the transverter's capability with that of most home stations, power-amplifier stages are best implemented as external accessories. It's good design practice to limit the amount of gain in a single box to 30 dB or so, unless special efforts are taken to prevent feedback.

Receive Converter

The transverter's receive-converter noise figure (NF) is approximately 4.5 dB. This may seem high by today's standards, but it can be easily dropped to 1 dB or less by a modern GaAsFET preamplifier with a gain of 14 dB or more.

The transverter's first receive stage, an Avantek MSA-0685 MMIC, provides a 50- Ω input impedance to properly terminate an outboard preamp. The preamp can be mast mounted or connected directly to the transverter input.

Performance

When driven with 1 mW of 144-MHz RF, the transverter produces a clean 2304-MHz signal. The 1-dB compression point is 10 mW. All spurious products are down from the fundamental output by at least 50 dB. For a receive frequency of 2304.1 MHz, the measured image rejection is more than 70 dB and the measured NF is 4.3 dB.

Be careful not to exceed the transmit mixer's maximum drive rating of 0 dBm (1 mW). If you have extra transmit gain

in your final configuration, reduce the transmitter drive.

Parts

Fig 2 is a part-placement drawing. Parts are available from Microwave Components of Michigan, PO Box 1697, Taylor, MI 48180; kits and assembled units are available from

Down East Microwave, RR1 Box 2310, Troy, ME 04987, tel 207-948-3471, fax 207-948-5157. As in the 3456-MHz transverter, the success of the no-tune approach depends on how accurately you can duplicate the printed filters. I strongly recommend you purchase the board from Down East Microwave, instead of trying to make your own.

Extrait du livre recueil
American Radio Relay League,
UHF/Microwave Projects manual 1994-96

Grand merci à Jacques F6AJW

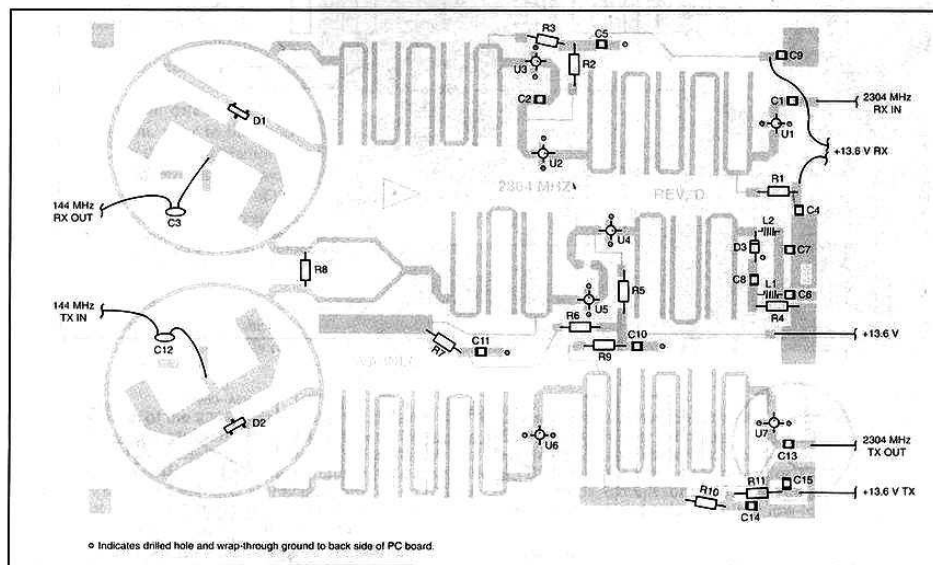
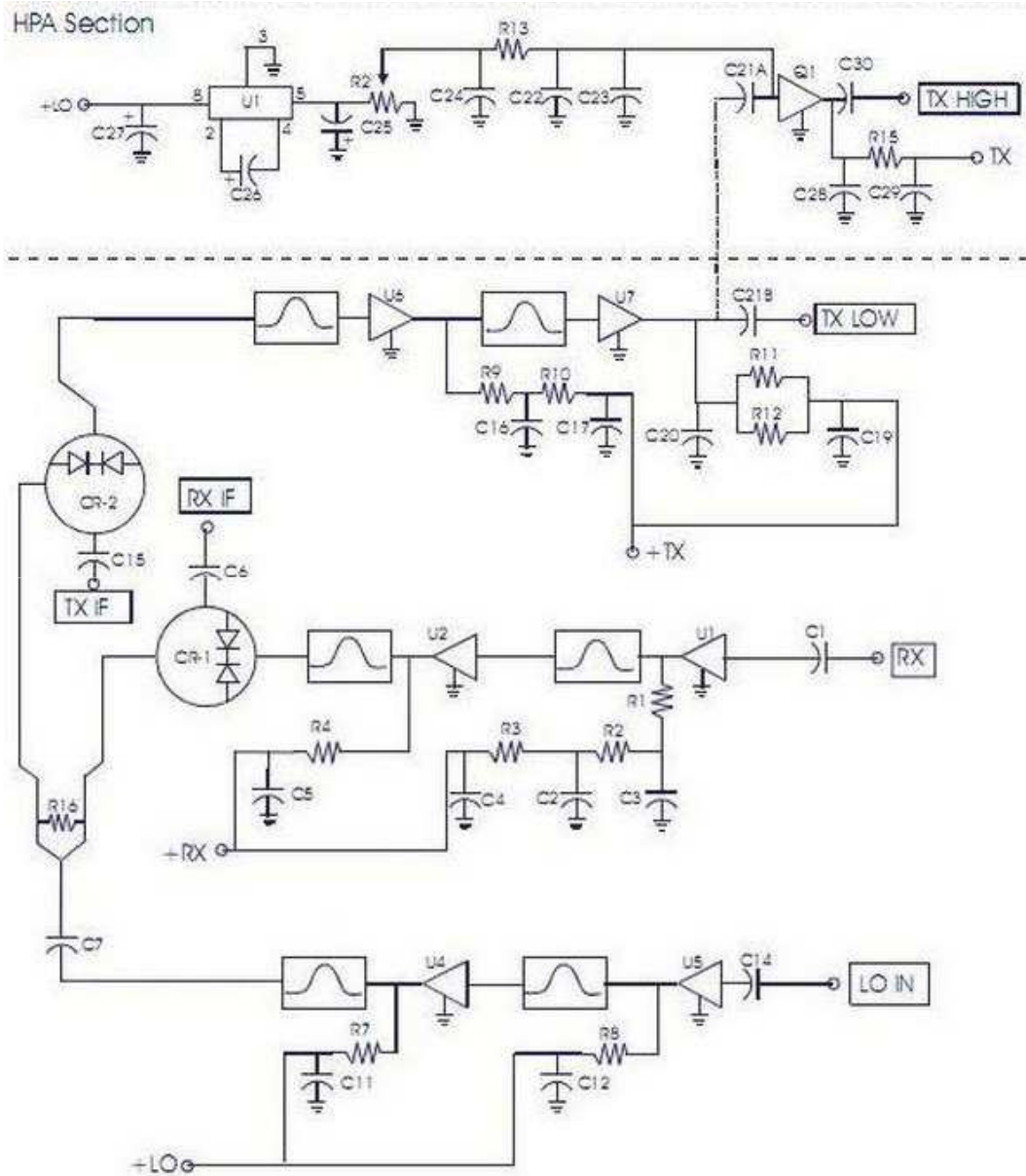

Fig 2—Part-placement guide for the 2304-MHz transverter (not shown actual size). All components mount on the etched side of the board. Feedthrough grounds, indicated by circles, must be installed and soldered top and bottom. Follow MMIC manufacturer's lead coding.

Synoptique total DEMI (plus récent)



- Différences par rapport à ce synoptique :
- pas d'étage Tx high power
 - aucun réglage Tx ou Rx par potard

Printboard platine RF mélangeuse DEMI (plus récent)

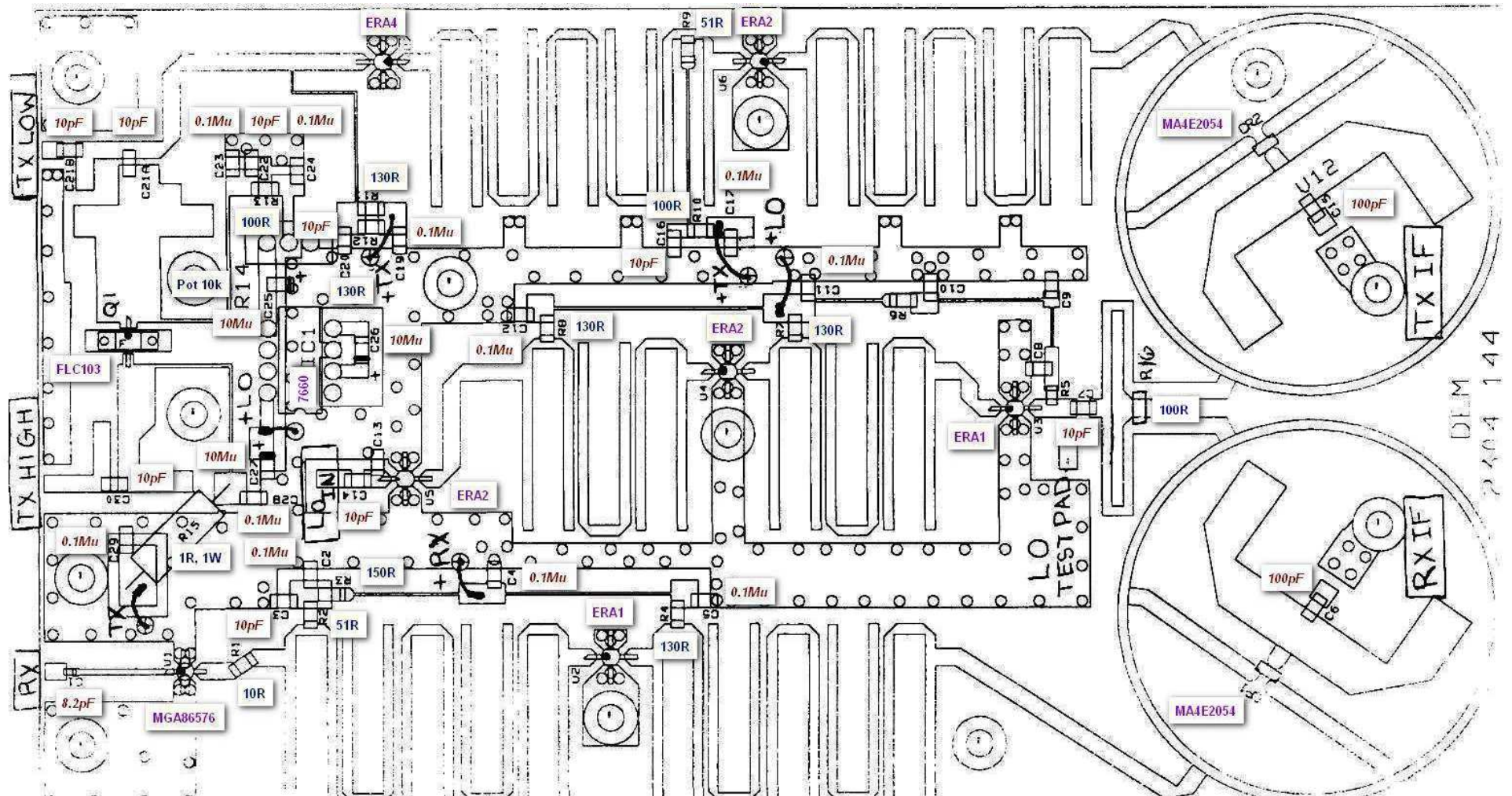

Composants platine RF mélangeuse DEMI (plus récent)

2304 Transverter Board Parts List

All components are Surface Mount components unless otherwise noted.

C1 8.2 pF ATC	C12 0.1 μF	R1 10 Ω	R11 130 Ω	U6 ERA-2
C2 0.1 μF	C14 10 pF	R2 51 Ω	R12 130 Ω	U7 ERA-4
C3 10 pF	C15 100 pF	R3 150 Ω	R13 100 Ω	CR1 MA4E2054
C4 0.1 μF	C16 10 pF	R4 130 Ω	U1 MGA86576	CR2 MA4E2054
C5 0.1 μF	C17 0.1 μF	R7 130 Ω	U2 ERA-1	
C6 100 pF	C19 0.1 μF	R8 130 Ω	U3 ERA-1	
C7 10 pF	C20 10 pF	R9 51 Ω	U4 ERA-2	
C11 0.1 μF	C21 10 pF (A&B)	R10 100 Ω	U5 ERA-2	

Dans notre cas, impossible de savoir avec exactitude les références des circuits U2 à U7 utilisés

2304-144 PA SECTION

C22 10 pF	C25 10.0 μF	C28 0.1 μF	R13 51 Ω	IC1 7660
C23 0.1 μF	C26 10.0 μF	C29 0.1 μF	R14 10K pot	Q1 FLC 103
C24 0.1 μF	C27 10.0 μF	C30 10 pF	R15 1Ω, 1Watt	2- sets of 0-80 screw, nut

Synoptique oscillateur LO DEMI

Platine LO 544 MHz seule

(ne comprend pas la partie diode multiplicatrice x4 + buffer situés au milieu de la platine RF)

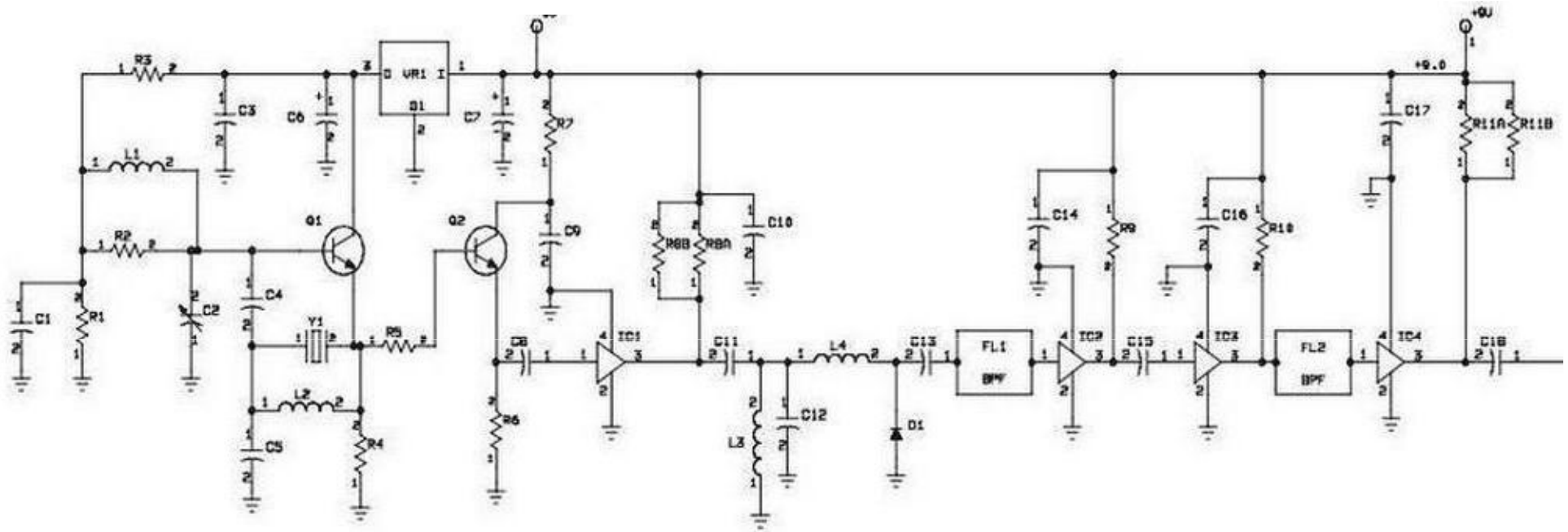

Bande 2304 MHz USA :

- FI 146 MHz
- LO = 2158 MHz
- LO intermédiaire = 539 MHz
- **Qz 89.9166 MHz**

Bande 2320 MHz Europe :

- FI 144 MHz
- LO = 2176 MHz
- LO intermédiaire = 544 MHz
- **Qz 90.6666 MHz**

Printboard platine LO DEMI (plus récent)

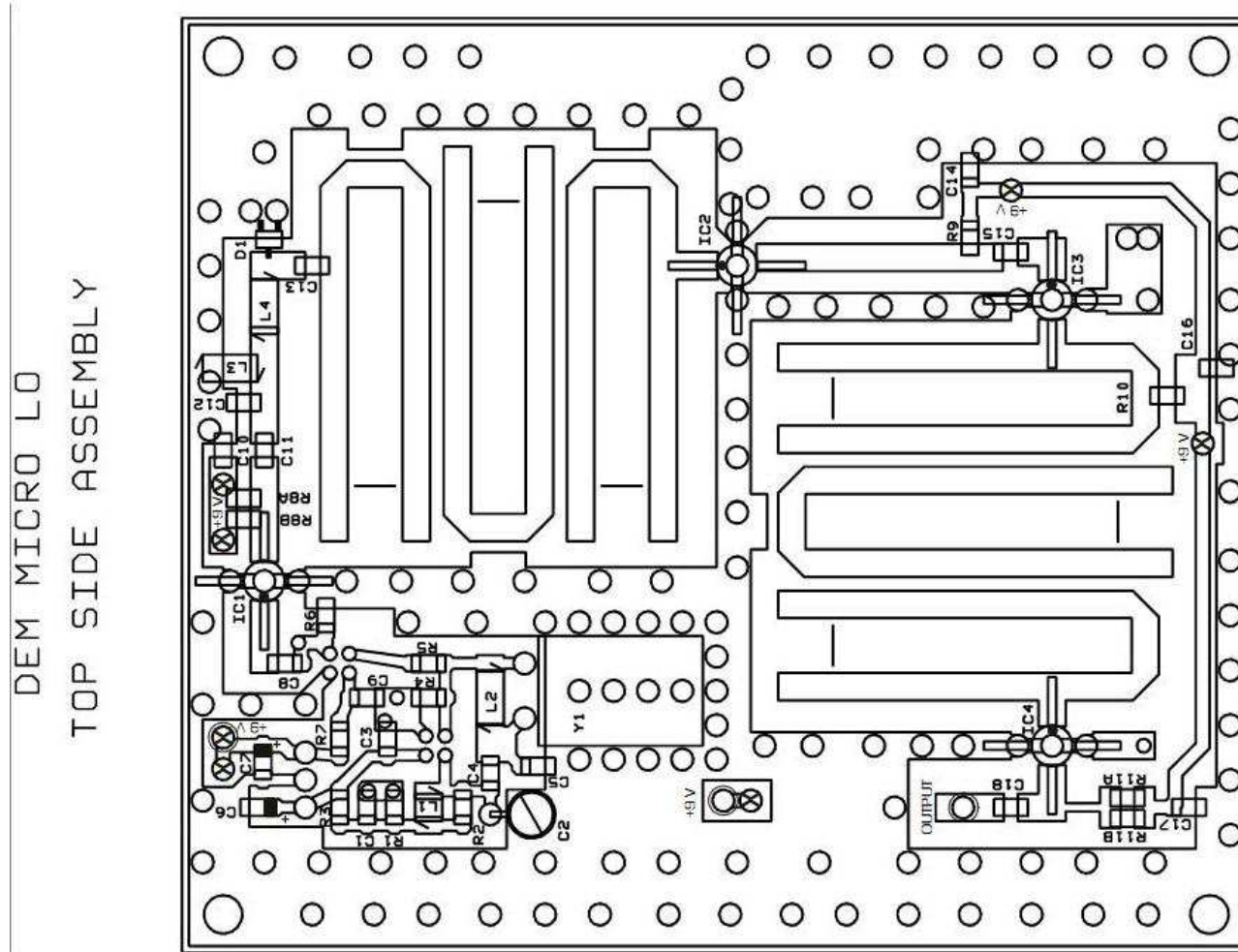

Ici, les 2 groupes de 3 filtres interdigités sont placés à 90° (pas le cas sur la platine actuellement utilisée)

Synoptique platine commutation DEMI (plus récente)

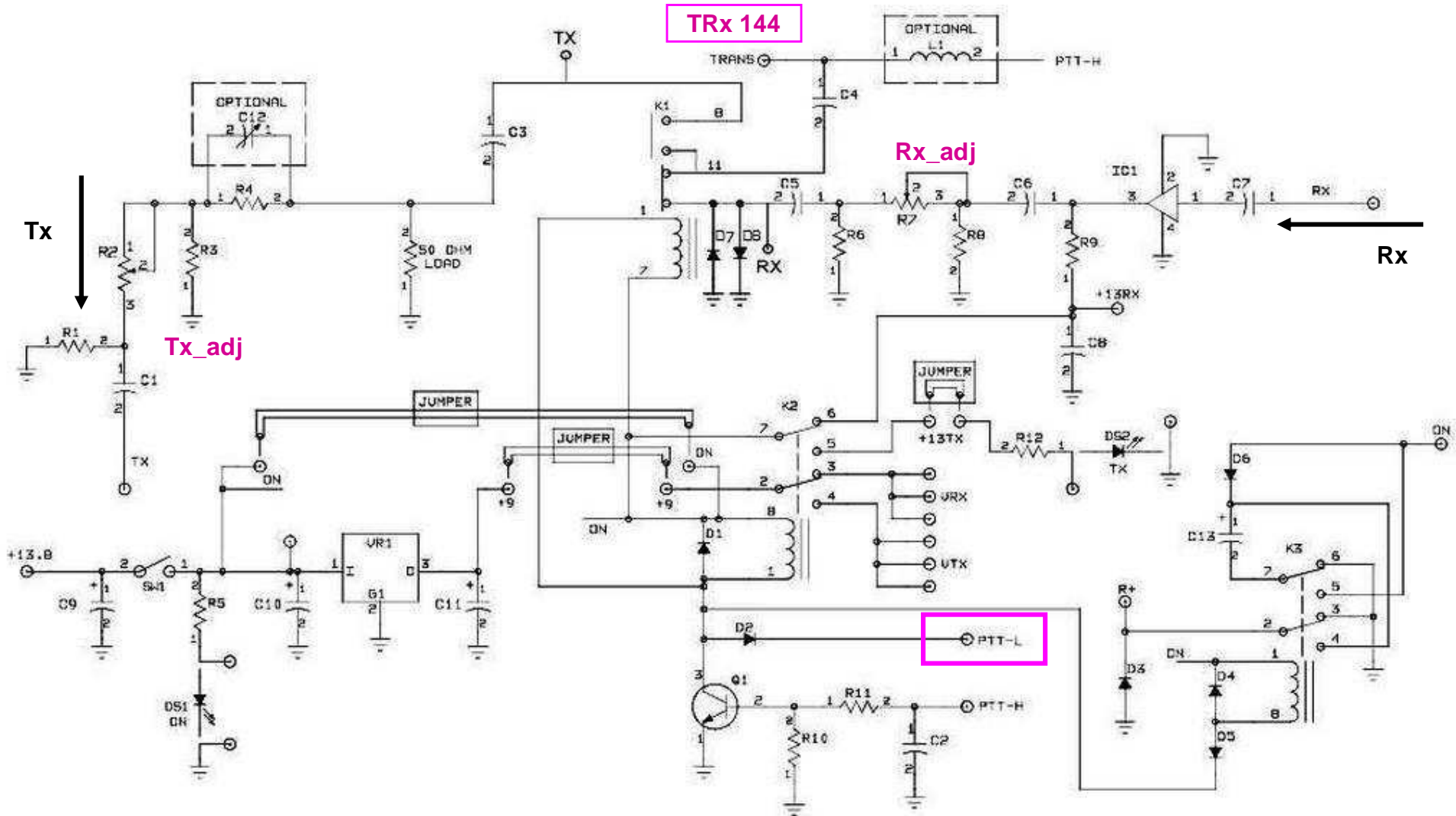

Printboard platine commutation DEMI (plus récente)

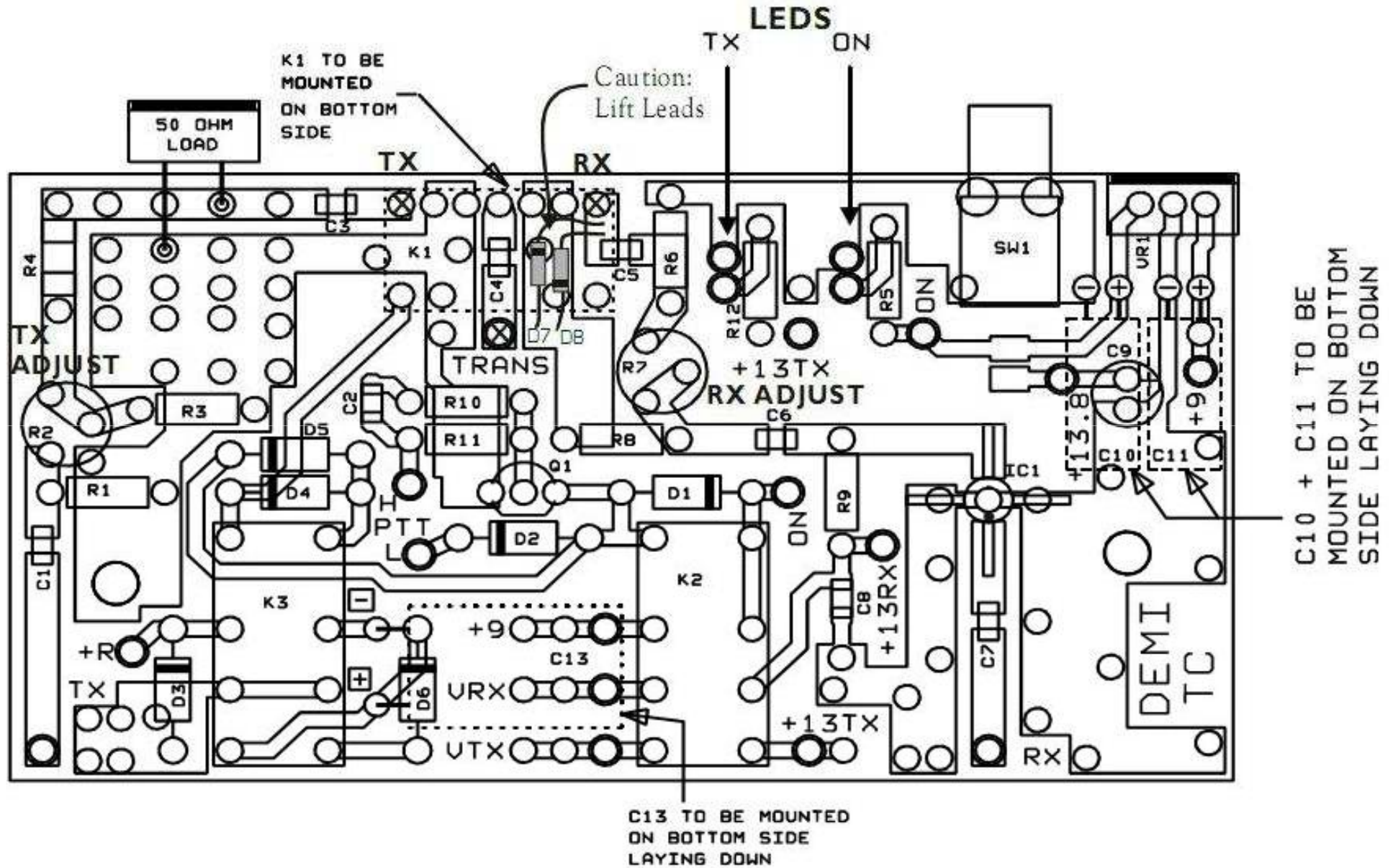

3- Prise en main

Aspect extérieur fermé

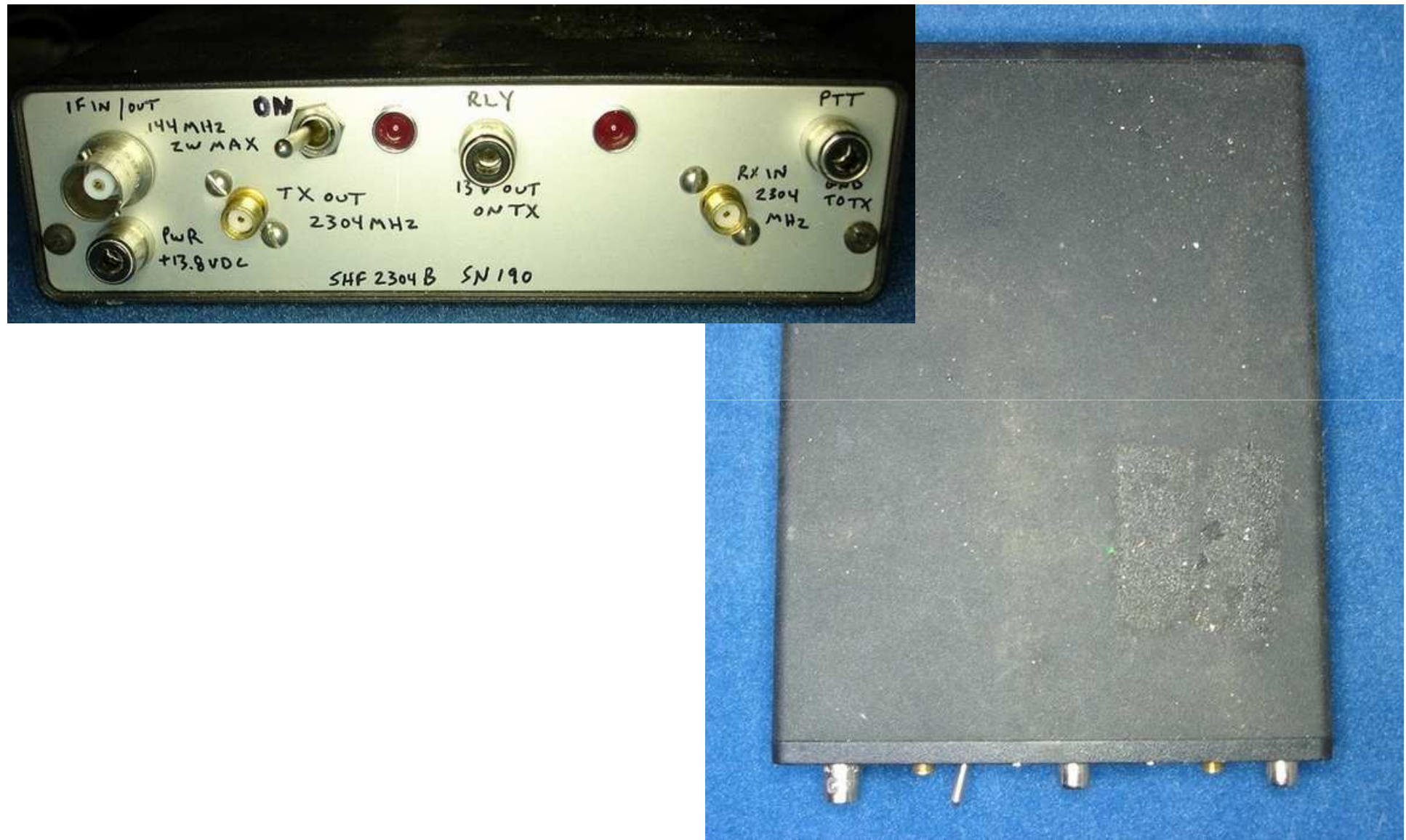

Aspect intérieur

Se compose de :

- Platine RF Tx/Rx avec :

Étage Rx

Étage Tx

Multiplicateur à diode + buffer + mélangeur Wilkinson Rx/Tx

- Platine LO 544 MHz (Pout \geq +10dBm)

- Platine commutation DC_PTT et RF à diode PIN (*rajoutée - réelle sensation de rafistolage*)

Aspect intérieur

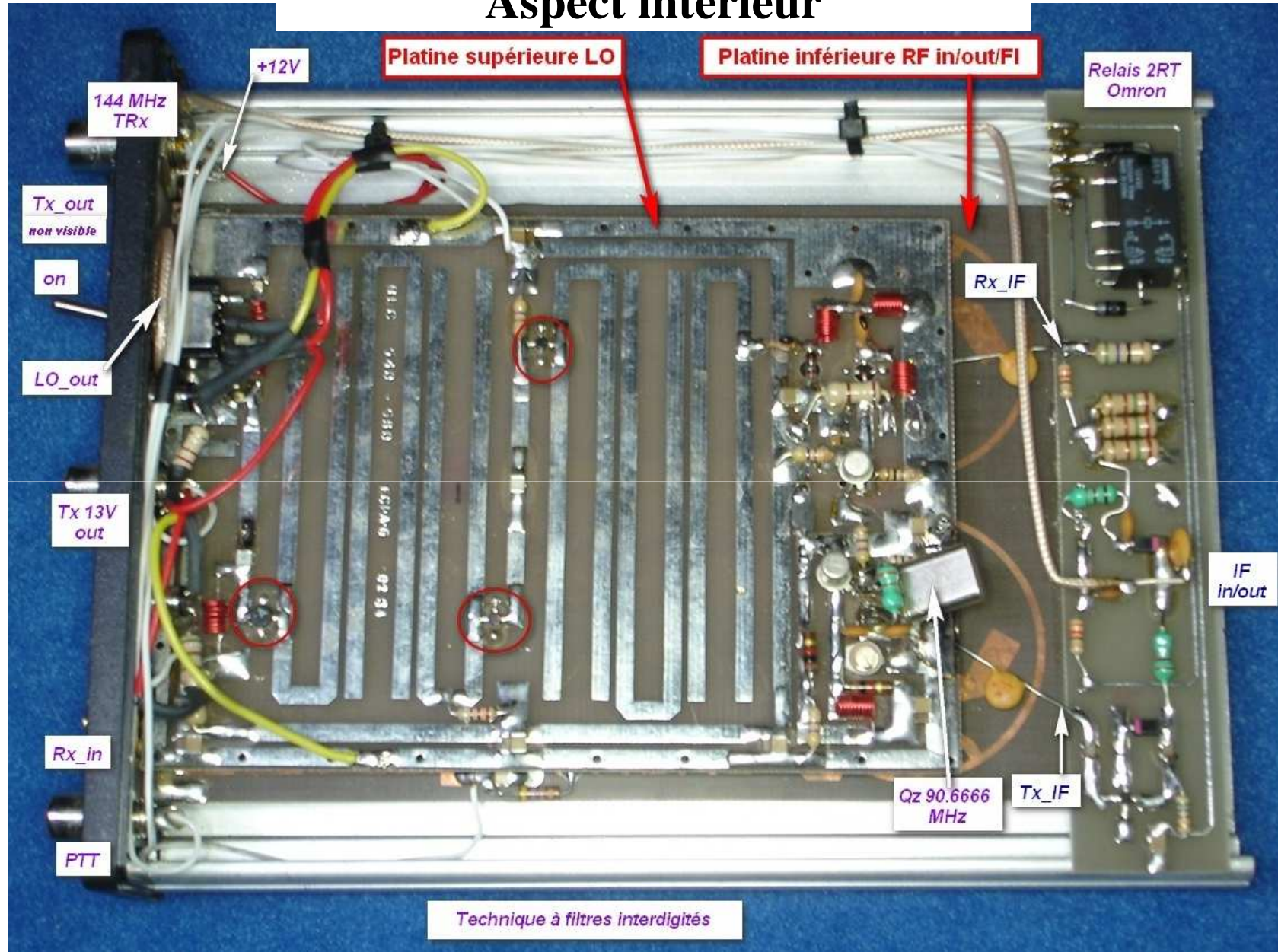

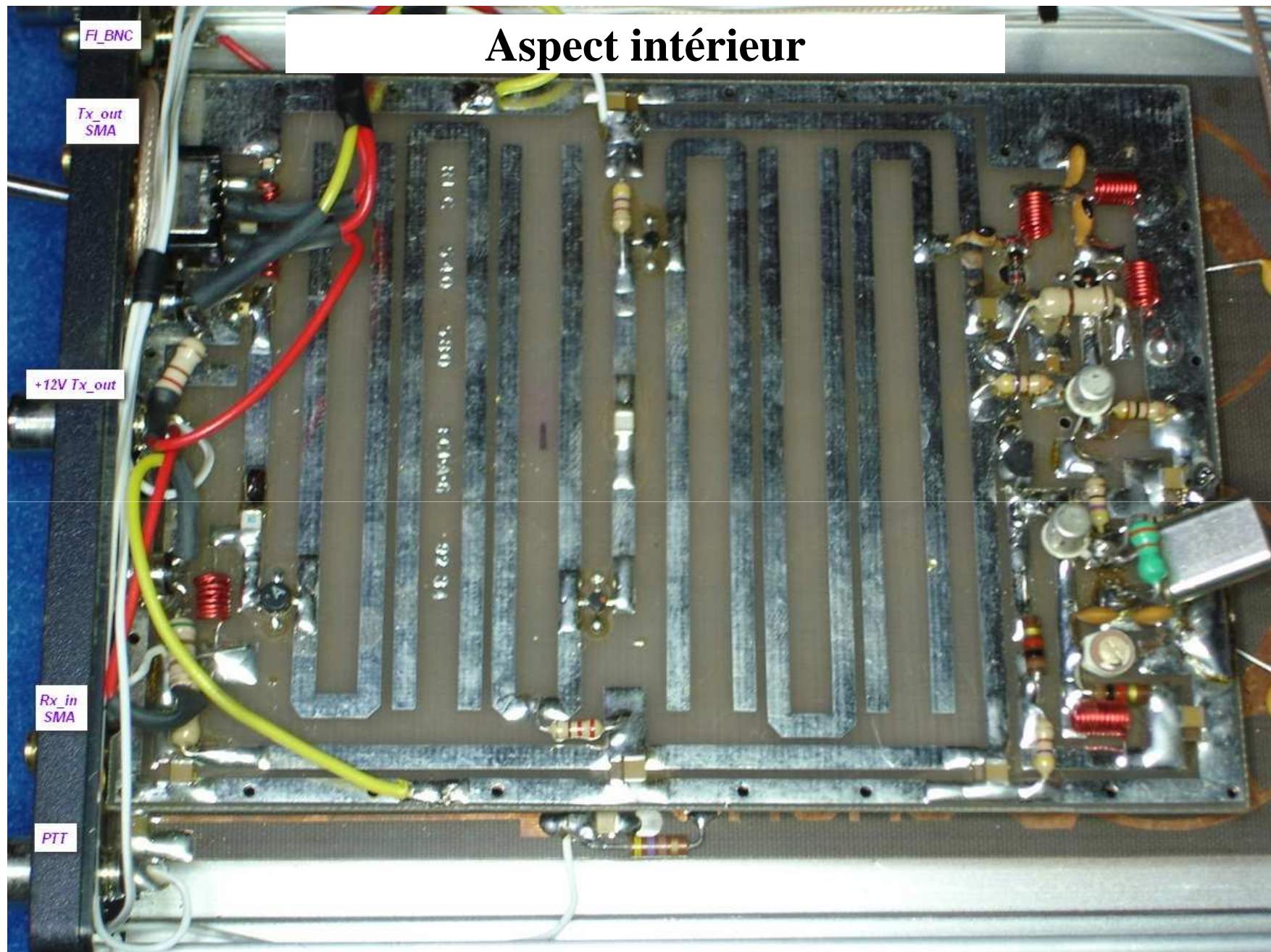

Aspect intérieur

Platine LO : 3 vis de fixation totalement inaccessibles

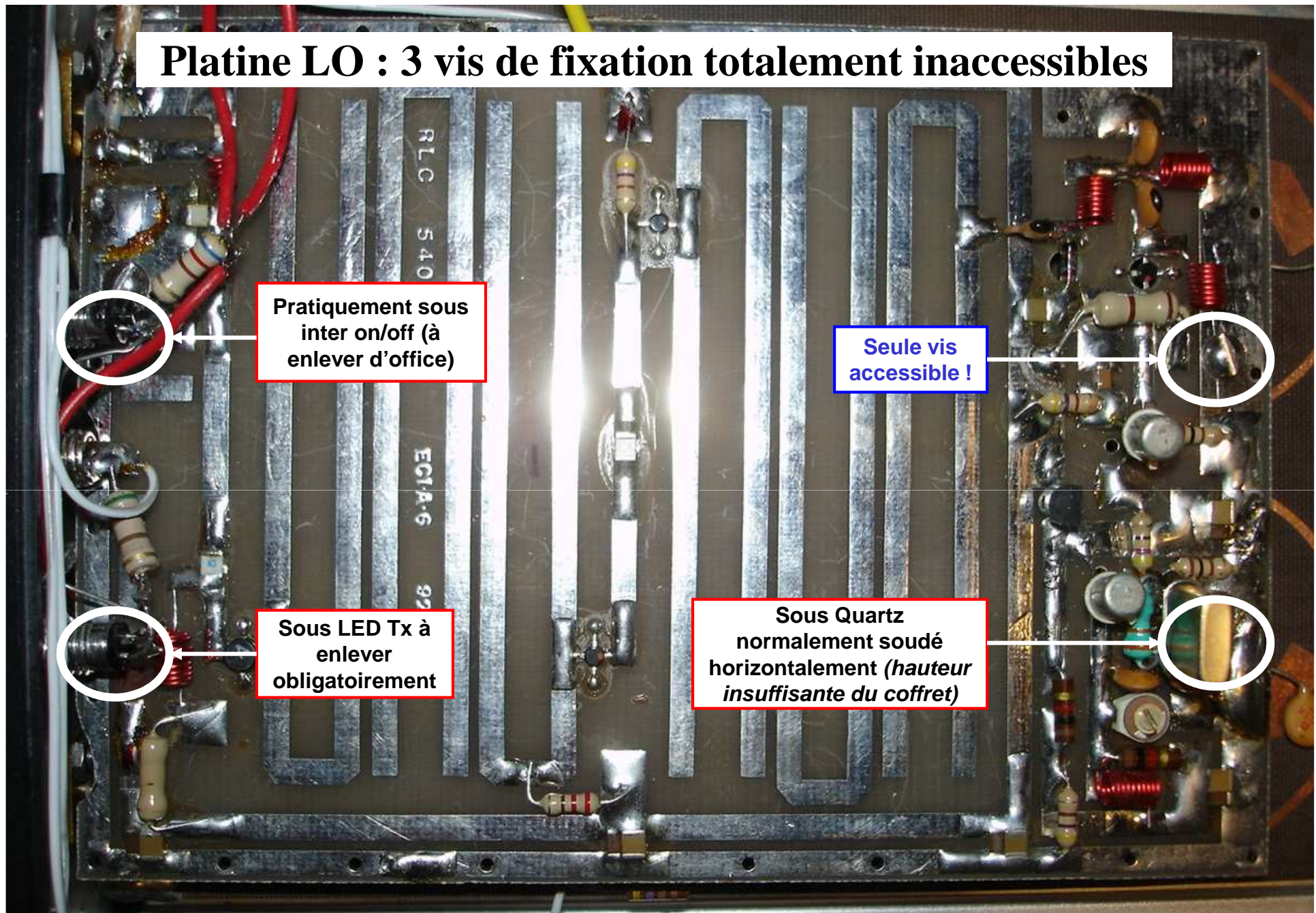

Platine LO : 3 vis de fixation totalement inaccessibles

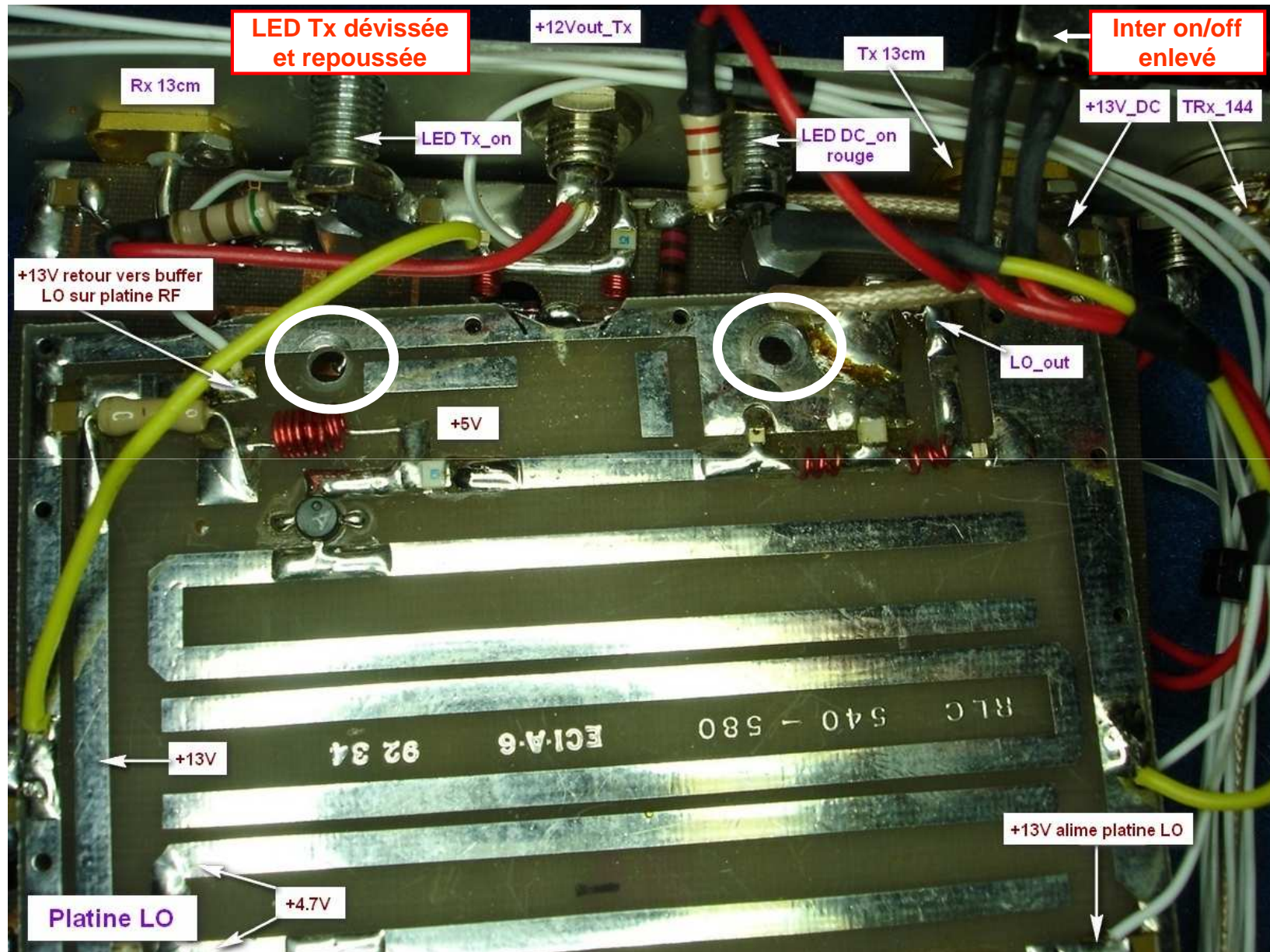

Platine LO : oscillateur à Quartz seul

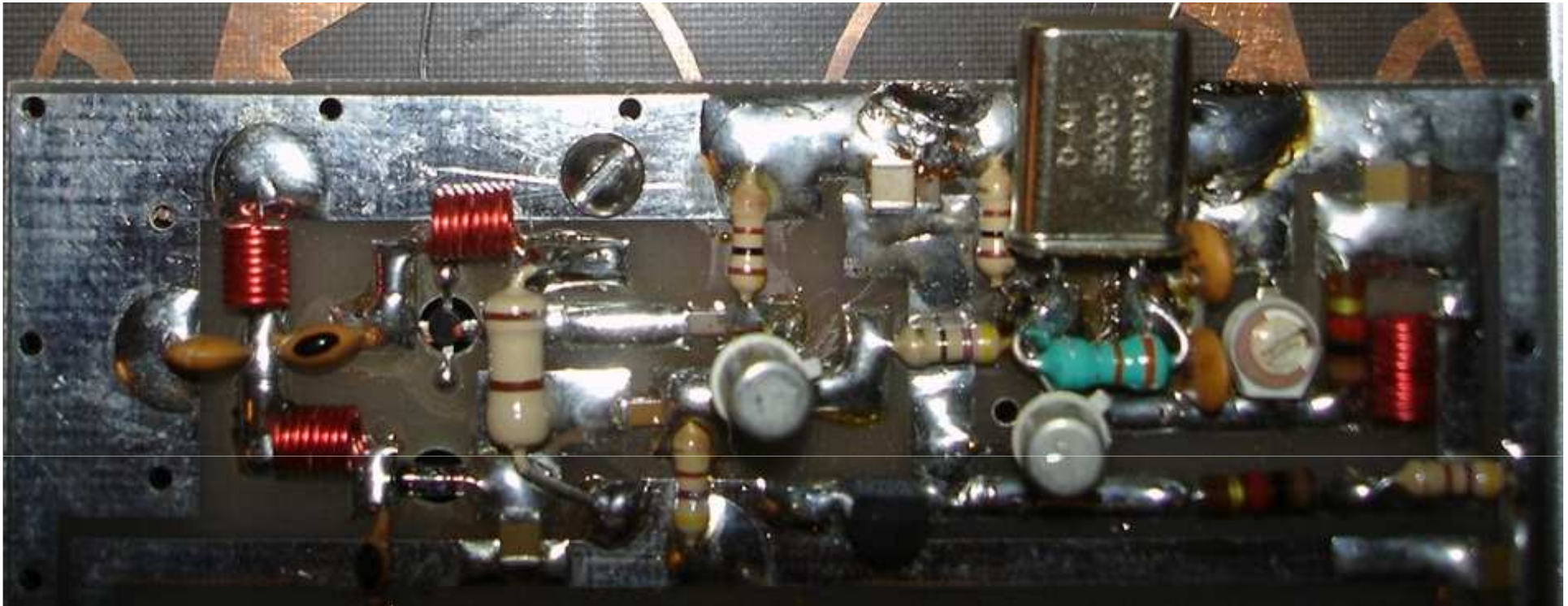

Platine LO : zoom sur oscillateur à Quartz

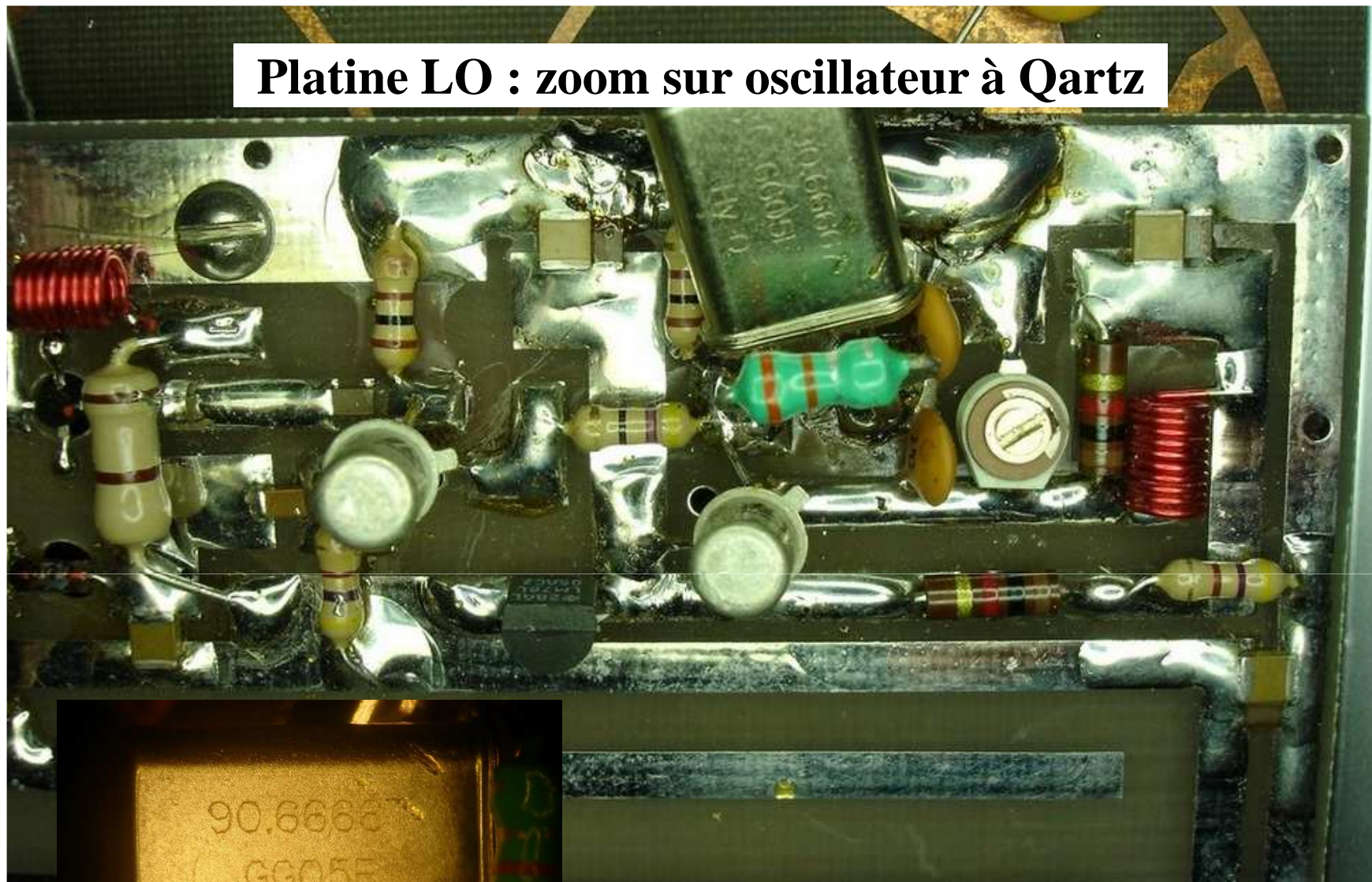

Partie arrière de la face avant : vis fixation LO inaccessibles

2 vis d'accès à l'avant de la platine LO absolument inaccessibles, sans devoir dessouder et enlever inter et LED Tx !

Seulement après, on arrive à extraire la platine LO et accéder enfin à la platine RF mélangeuse !

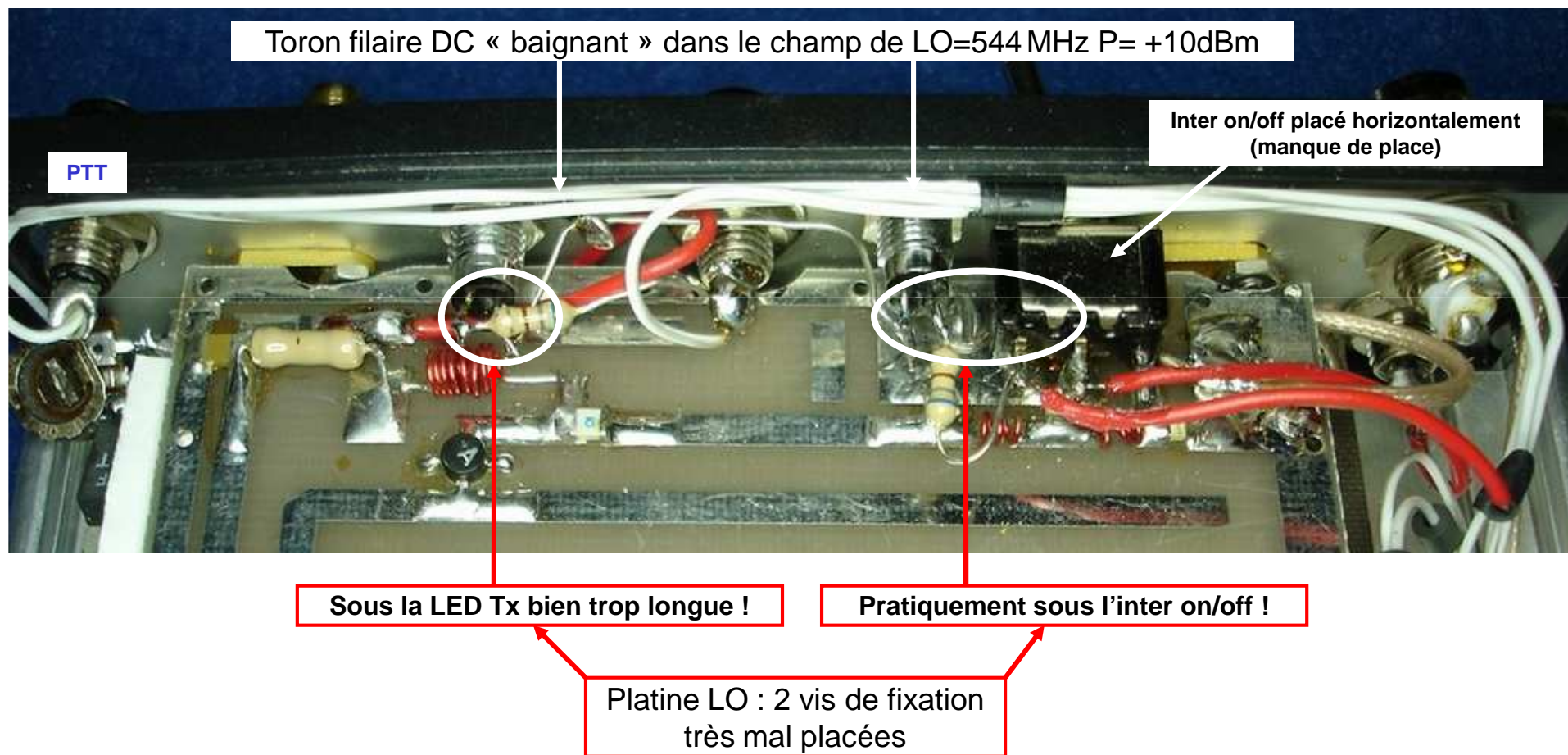

Platine LO : tensions DC mesurées

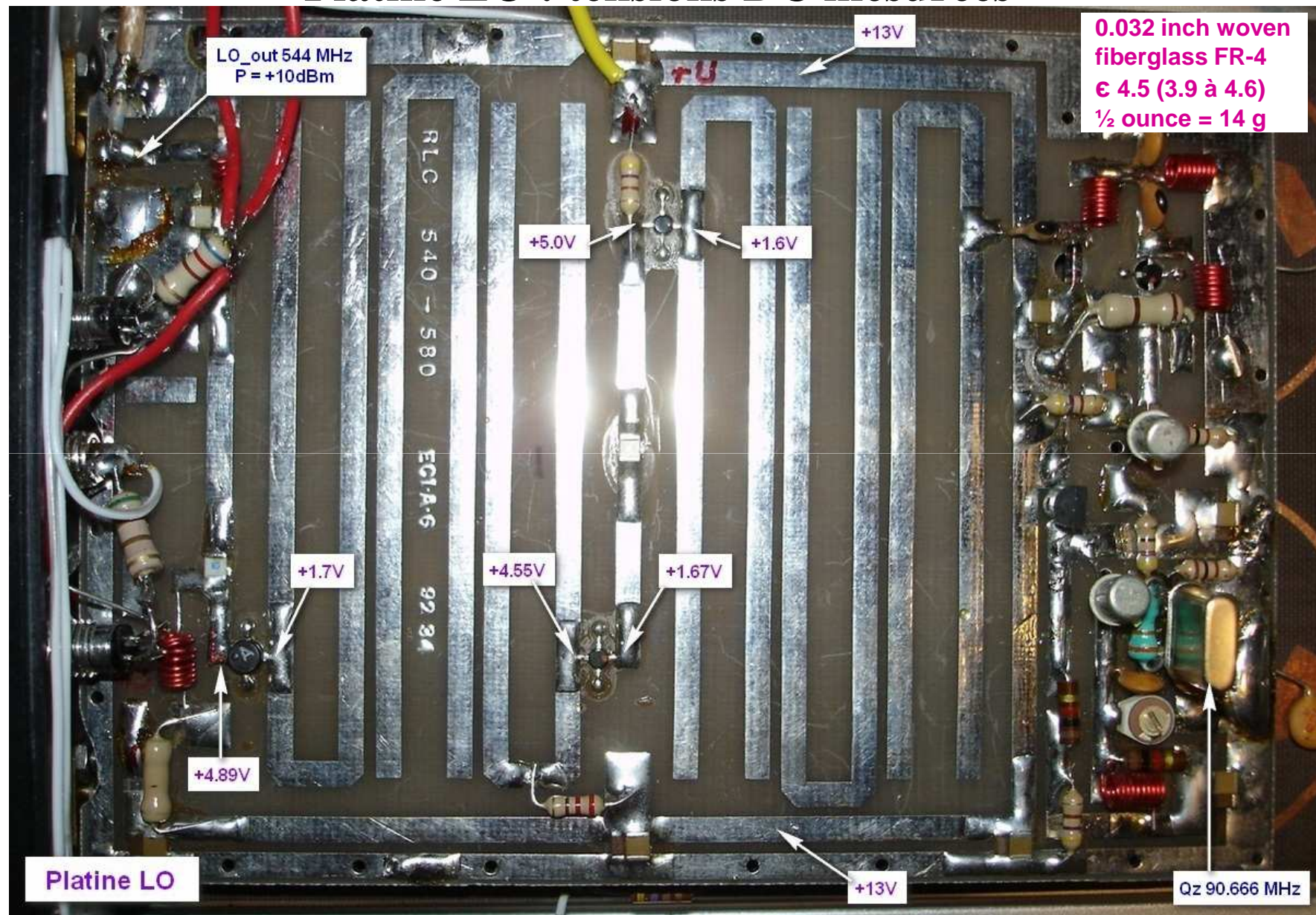

Platine Rx mélangeuse : enfin accessible !

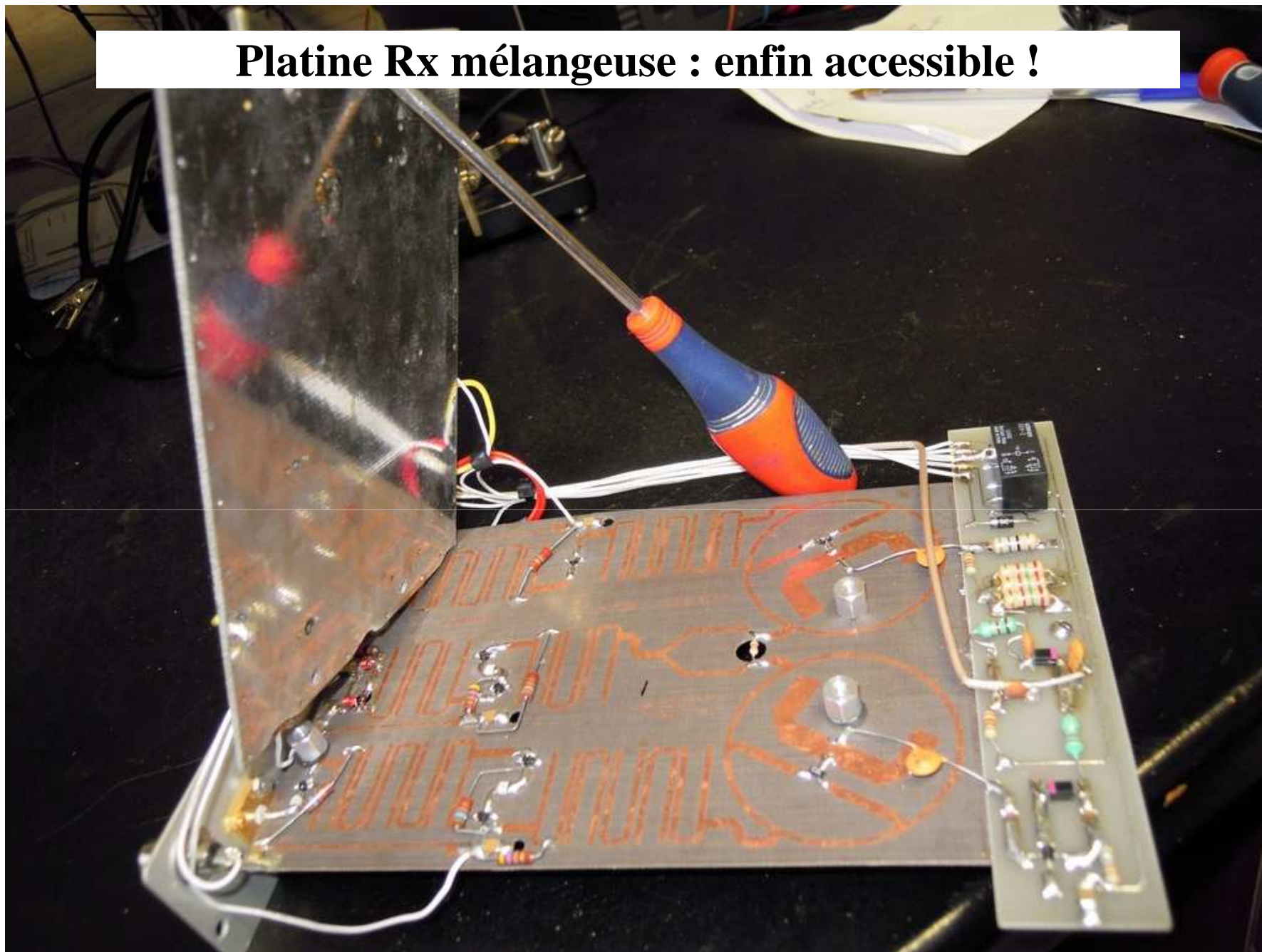

4- Transformation partie Rx

But : abaisser le Nf actuel de 4.5dB

Modification de N2CEI substituant le 1er étage par un MGA-86576 Avago

Opérations effectuées en remontant le CI mélangeur RF dans sa ½ coquille inférieure

Specs du MGA-86576

MGA-86576

1.5 – 8 GHz Low Noise
GaAs MMIC Amplifier



Data Sheet

Description

Avago's MGA-86576 is an economical, easy-to-use GaAs MMIC amplifier that offers low noise and excellent gain for applications from 1.5 to 8 GHz.

The MGA-86576 may be used without impedance matching as a high performance 2 dB NF gain block. Alternatively, with the addition of a simple series inductor at the input, the device noise figure can be reduced to 1.6 dB at 4 GHz.

The circuit uses state-of-the-art PHEMT technology with self-biasing current sources, a source-follower interstage, resistive feedback, and on chip impedance matching networks.

A patented, on-chip active bias circuit allows operation from a single +5 V power supply. Current consumption is only 16 mA.

These devices are 100% RF tested to assure consistent performance.

Surface Mount Ceramic Package

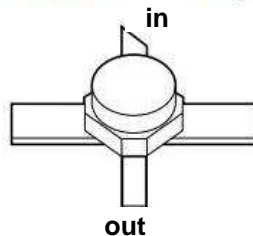

Features

- 1.6 dB Noise Figure at 4 GHz
- 23 dB Gain at 4 GHz
- +6 dBm P_{1dB} at 4 GHz
- Single +5 V Bias Supply

Applications

- LNA or Gain Stage for 2.4 GHz and 5.7 GHz ISM Bands
- Front End Amplifier for GPS Receivers
- LNA or Gain Stage for PCN and MMDS Applications
- C-Band Satellite Receivers
- Broadband Amplifier for Instrumentation

Schematic Diagram

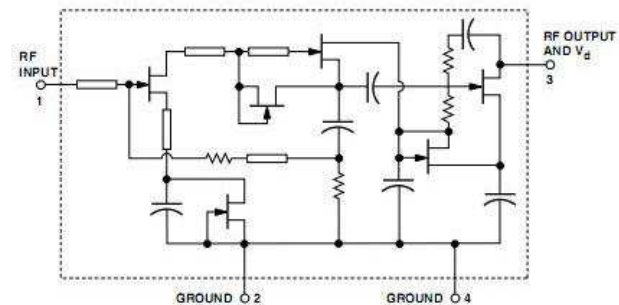

Specs du MGA-86576

MGA-86576 Electrical Specifications, $T_c = 25^\circ\text{C}$, $Z_0 = 50 \Omega$, $V_d = 5 \text{ V}$

Symbol	Parameters and Test Conditions	Units	Min.	Typ.	Max.
Gp	Power Gain ($ S_{21} ^2$)	f = 1.5 GHz		21.2	
		f = 2.5 GHz		23.7	
		f = 4.0 GHz	20	23.1	
		f = 6.0 GHz		19.3	
		f = 8.0 GHz		15.4	
NF ₅₀	50 Ω Noise Figure	f = 1.5 GHz		2.2	
		f = 2.5 GHz		1.9	
		f = 4.0 GHz		2.0	2.3
		f = 6.0 GHz		2.3	
		f = 8.0 GHz		2.5	
NF _o	Optimum Noise Figure (Input tuned for lowest noise figure)	f = 1.5 GHz		1.6	
		f = 2.5 GHz		1.5	
		f = 4.0 GHz		1.6	
		f = 6.0 GHz		1.8	
		f = 8.0 GHz		2.1	
P _{1dB}	Output Power at 1 dB Gain Compression	f = 1.5 GHz		6.4	
		f = 2.5 GHz		7.0	
		f = 4.0 GHz		6.3	
		f = 6.0 GHz		4.3	
		f = 8.0 GHz		3.8	

MGA-86576 Typical Performance, $T_c = 25^\circ\text{C}$, $Z_0 = 50 \Omega$, $V_d = 5 \text{ V}$

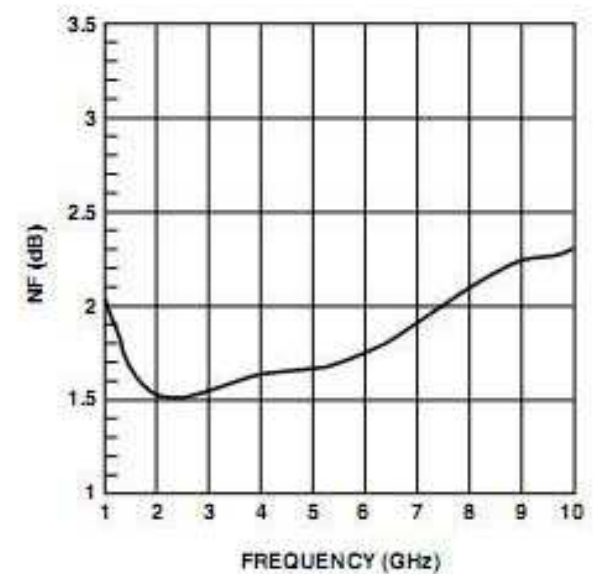
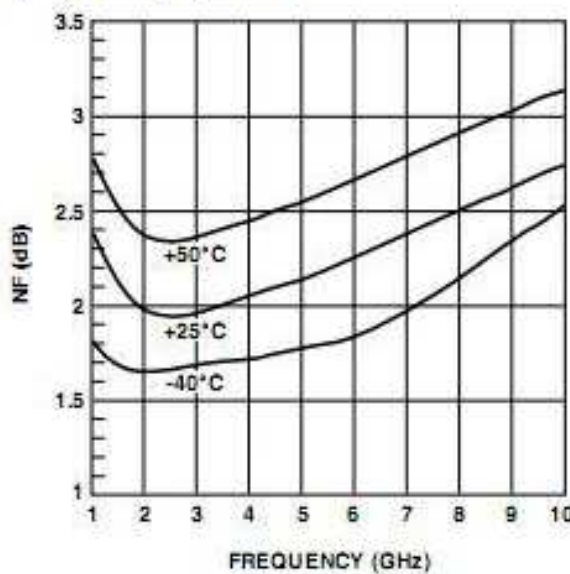
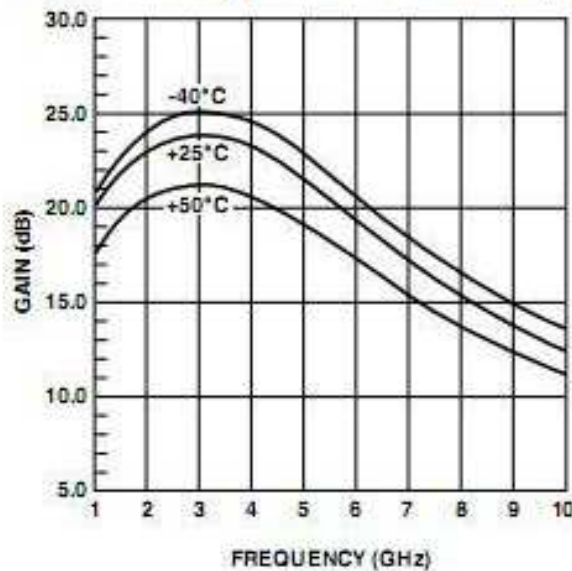

Platine Rx état initial

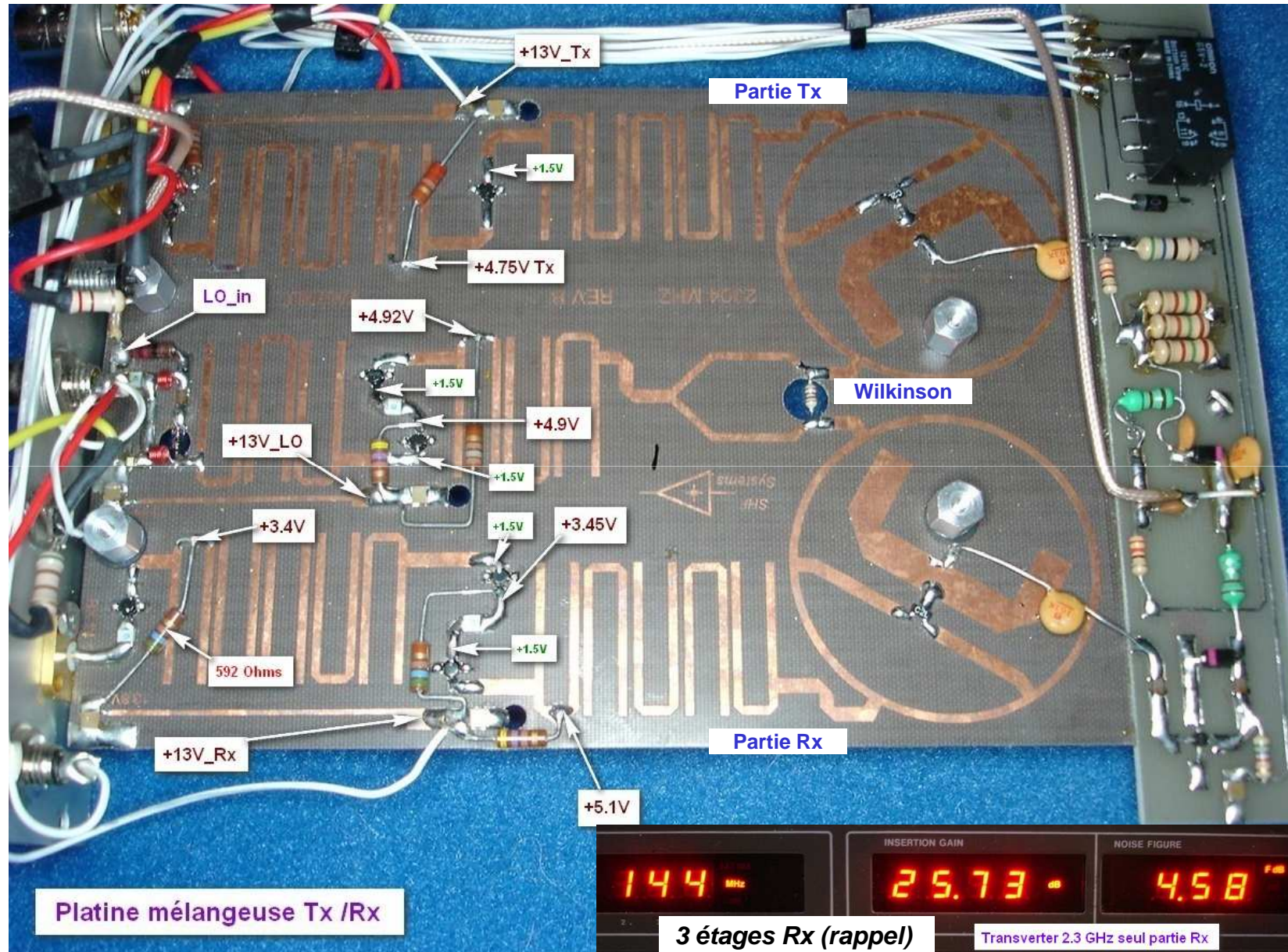

Platine Rx état initial

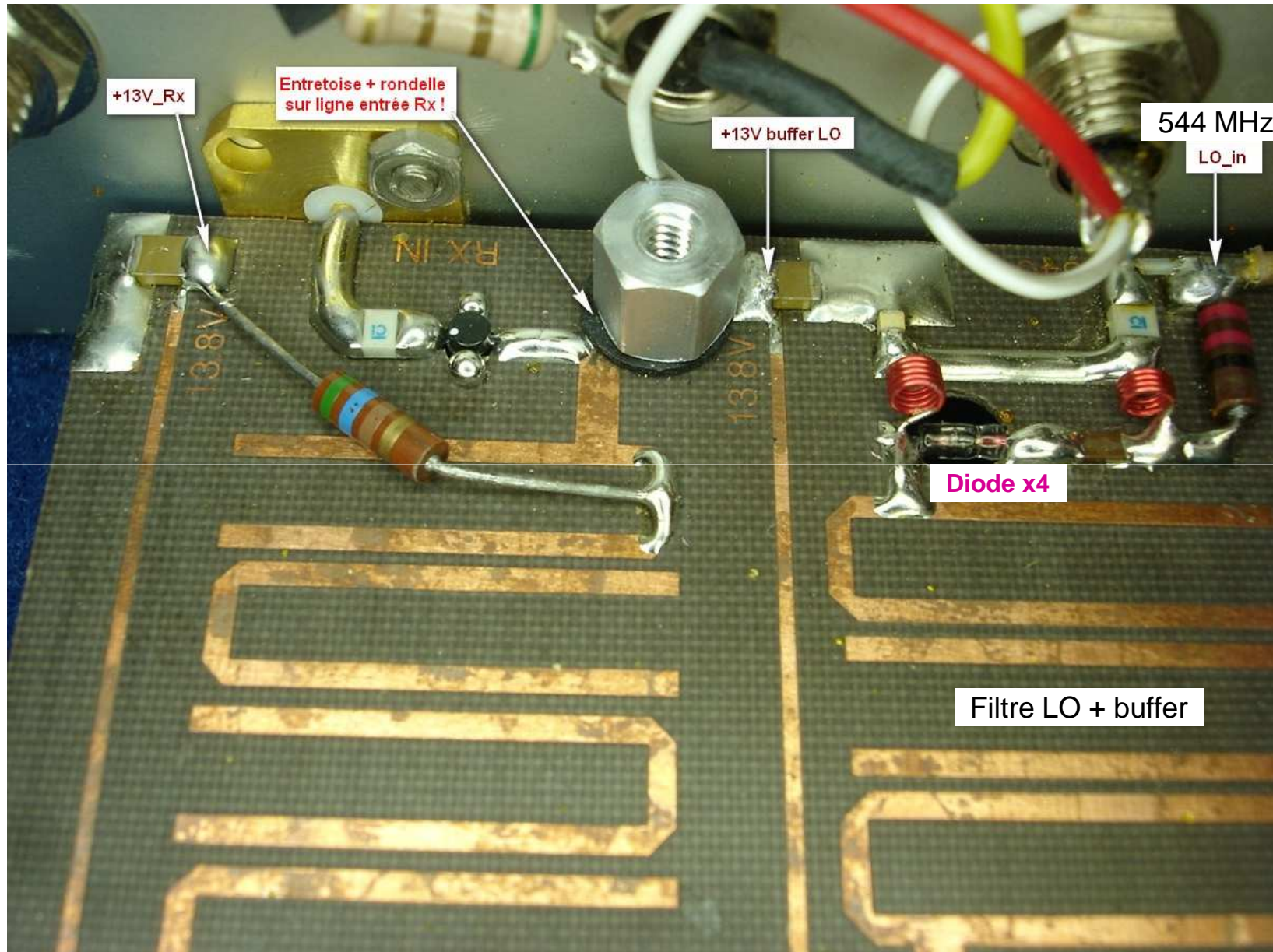

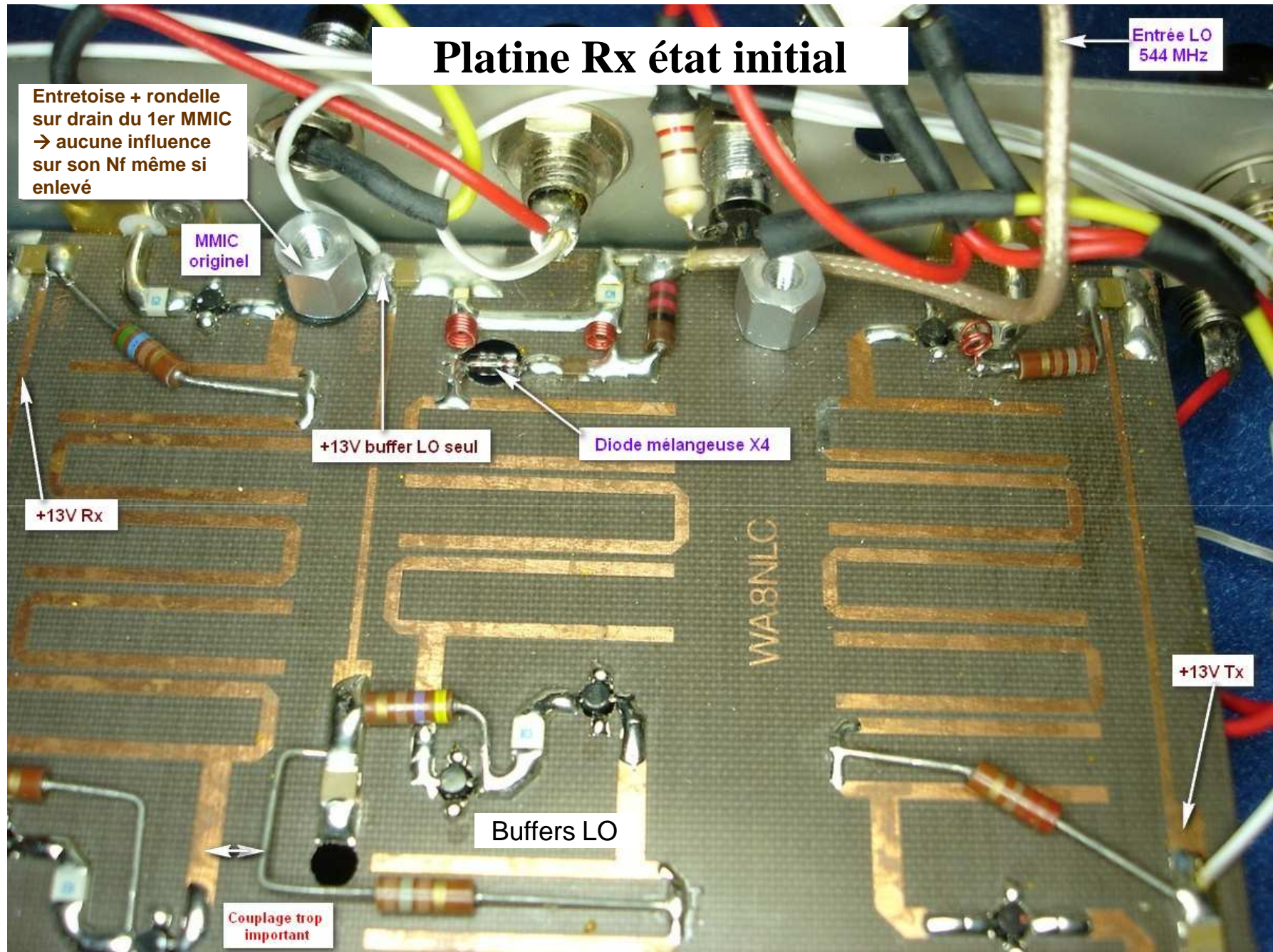

Platine Rx état initial

Entree LO
544 MHz

Entretoise + rondelle
sur drain du 1er MMIC
→ aucune influence
sur son Nf même si
enlevé

MMIC
originel

+13V buffer LO seul

Diode mélangeuse X4

+13V Rx

+13V Tx

Buffers LO

Couplage trop
important

Modification DEMI suggérée par N2CEI

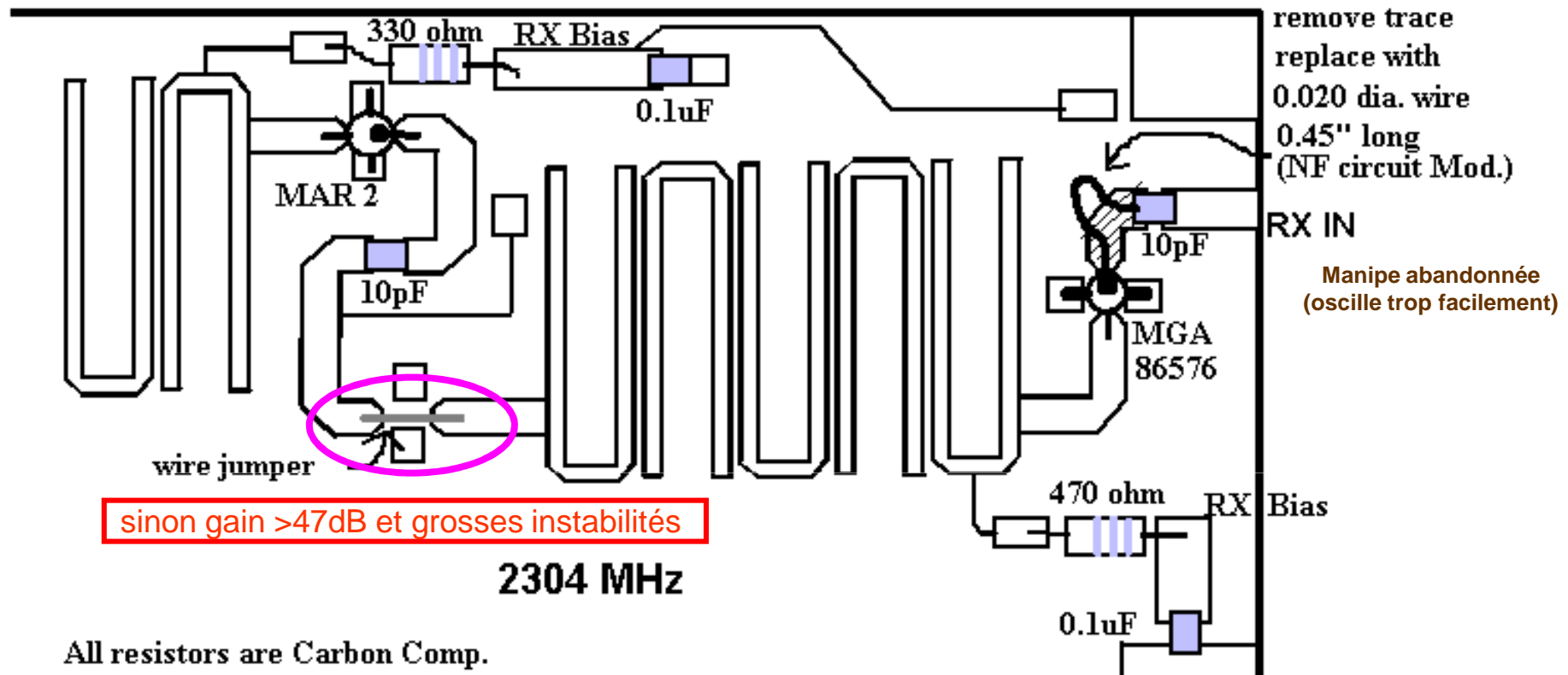

All resistors are Carbon Comp.

- Dégrossissage initial avec LO extérieur constitué par un Marconi 2031
- Avec accord rajouté en amont, oscillations pires que sans (oscillations)
- Obligation de stabiliser parfaitement l'alime du MGA86576 vers +5V
- Peaufinage obligatoire de la tension alime, en recherchant le bruit minimal

Absolument aucun problème si injection de 2304 MHz (LO injecté 539 MHz)

Problèmes de stabilité si injection de 2320 MHz (LO injecté 544 MHz), uniquement résolus avec absorbant RF

Platine Rx état final : dégrossissage sans 7808 additionnel

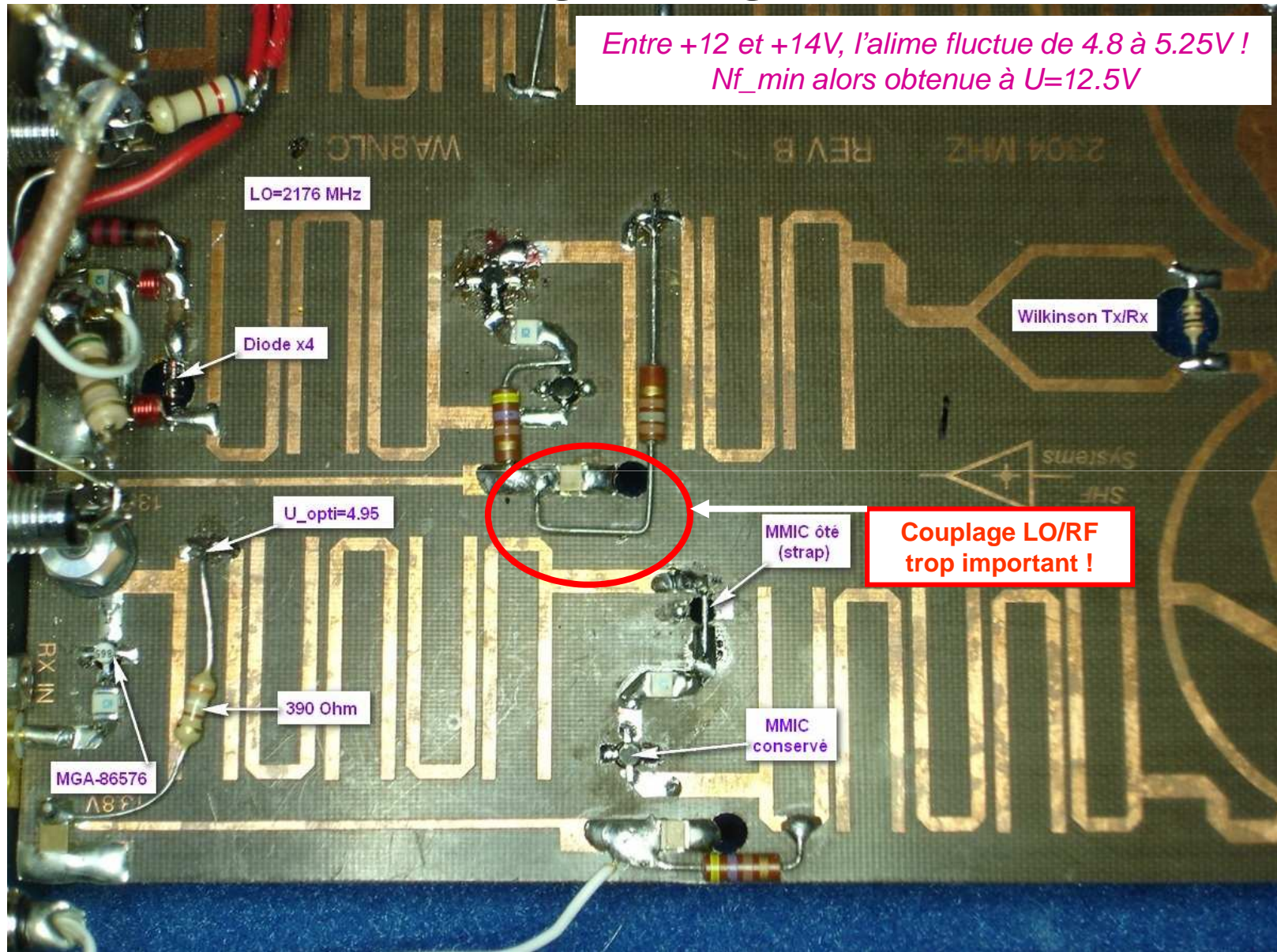

Platine Rx : état final

Opérations effectuées :

- Substitution du 1er étage par un MGA-86576
- Comme son alimentation fluctue en fonction de l'alime DC, un régulateur 7808 spécifique lui a ensuite été rajouté
- Résistance initiale de 470 Ω substituée par un ensemble 150 Ω + potard ajustable
- Le Nf_min ne peut être obtenu qu'avec une alimentation stable de 4.95V

Manipe de l'accord en amont → vives oscillations non maîtrisées pour le moment → abandon

Platine Rx : mesures



Couple gain/Nf parfaitement stable de $+11.8V < U_{alime} < 14.5V$

*Mais avec recours impératif d'absorbant RF placé entre les 2 platines, et au-dessus du MMIC Avago (j'aurai bien voulu faire sans, mais c'est totalement impossible) !!
Egalement réduction du couplage entre filtre interdigité Rx et alime du dernier buffer LO*

5- Platine commutation Tx/Rx

Rajout de la «compatibilité DB6NT» (Tx + DC superposée)

Platine «rafistolée» d'origine de commutation PTT

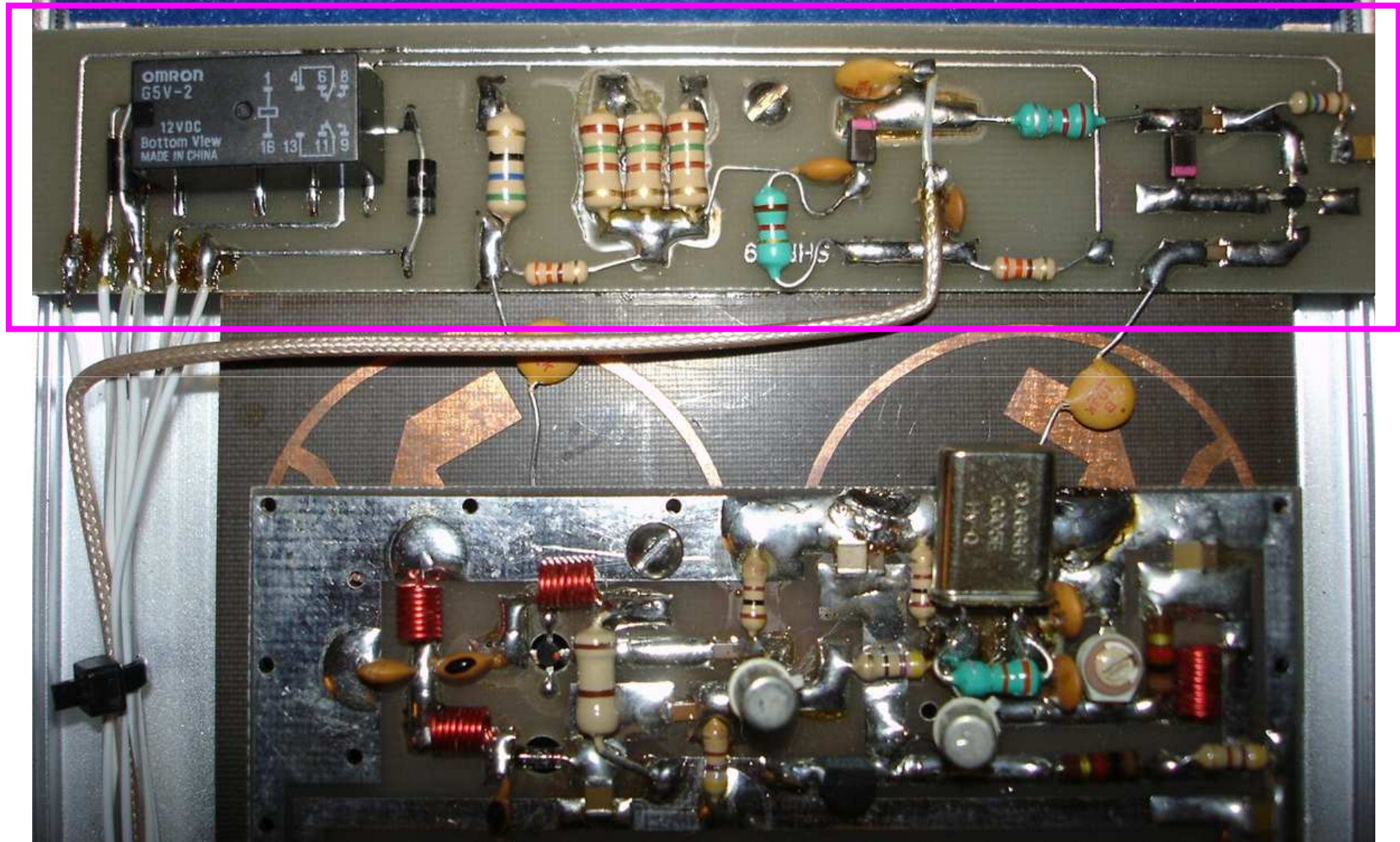

Platine de commutation PTT : zoom relais

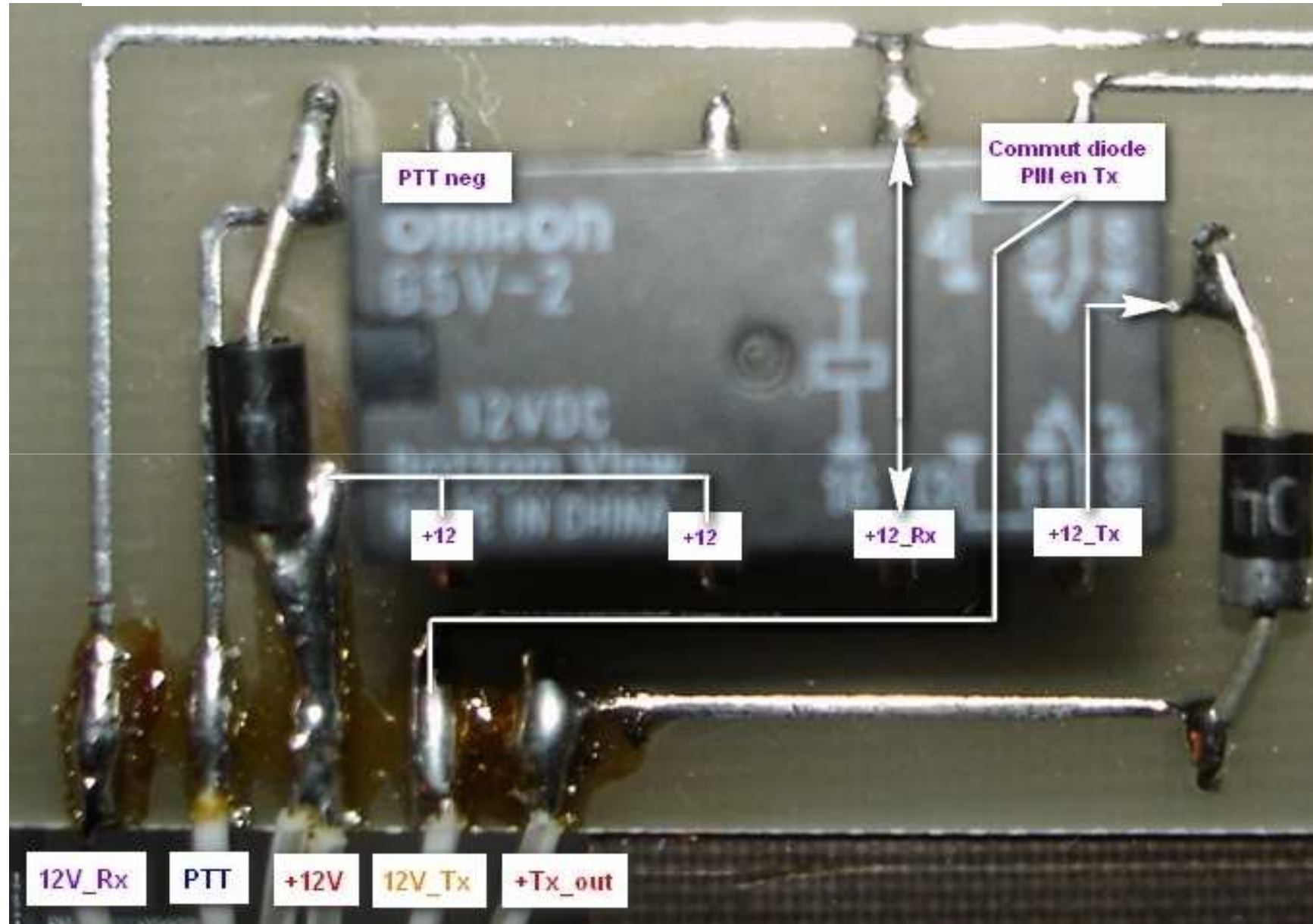

Platine de commutation PTT : zoom 144 MHz

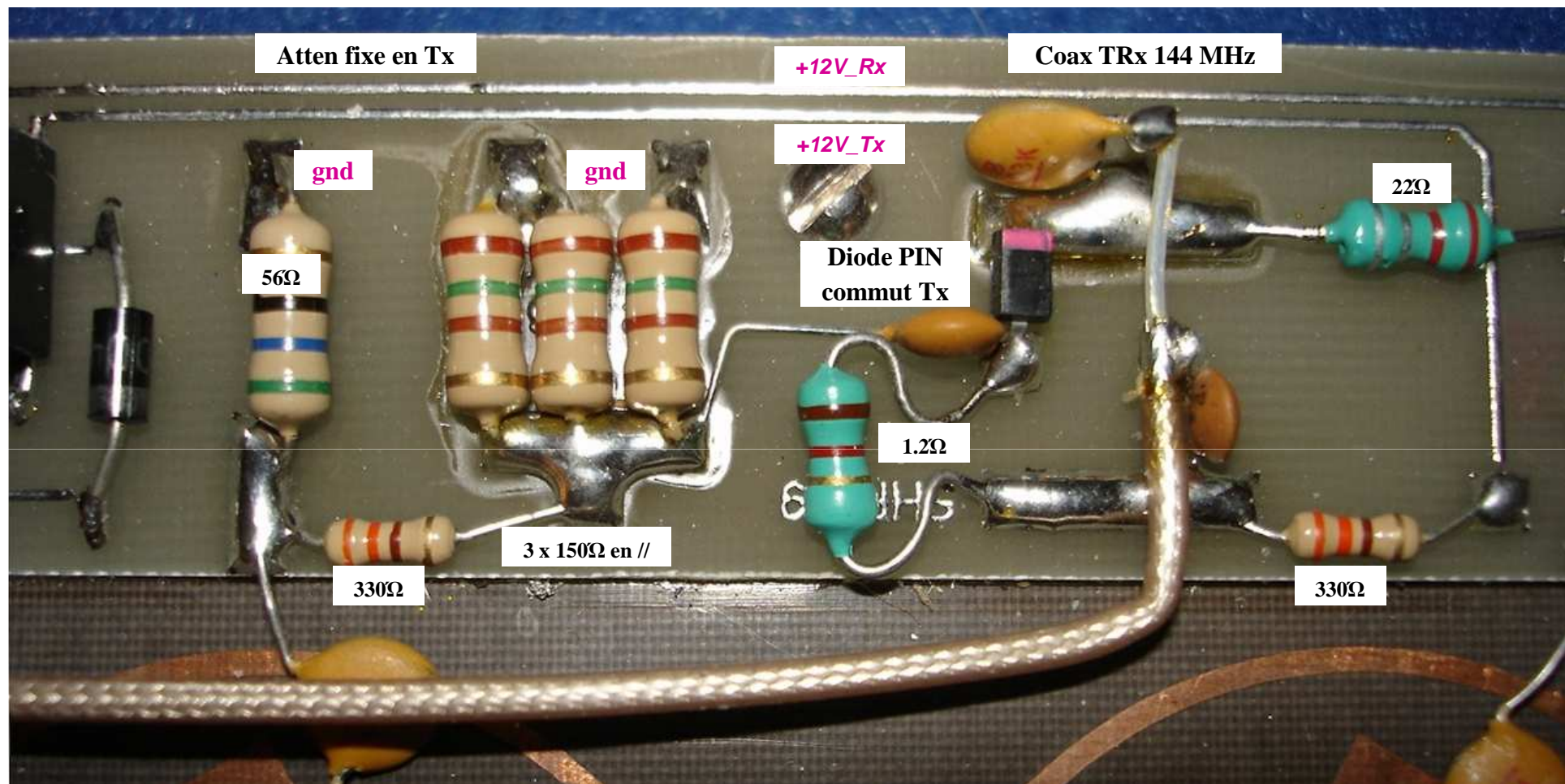

- Circuit imprimé rajouté, qui en fait aurait pu être intégré dans la platine Rx mélangeuse
- Pourquoi une commutation Tx / Rx à diodes PIN car le 2ème contact du relais Omron aurait parfaitement convenu pour cette application ?

Platine de commutation PTT : zoom partie Rx

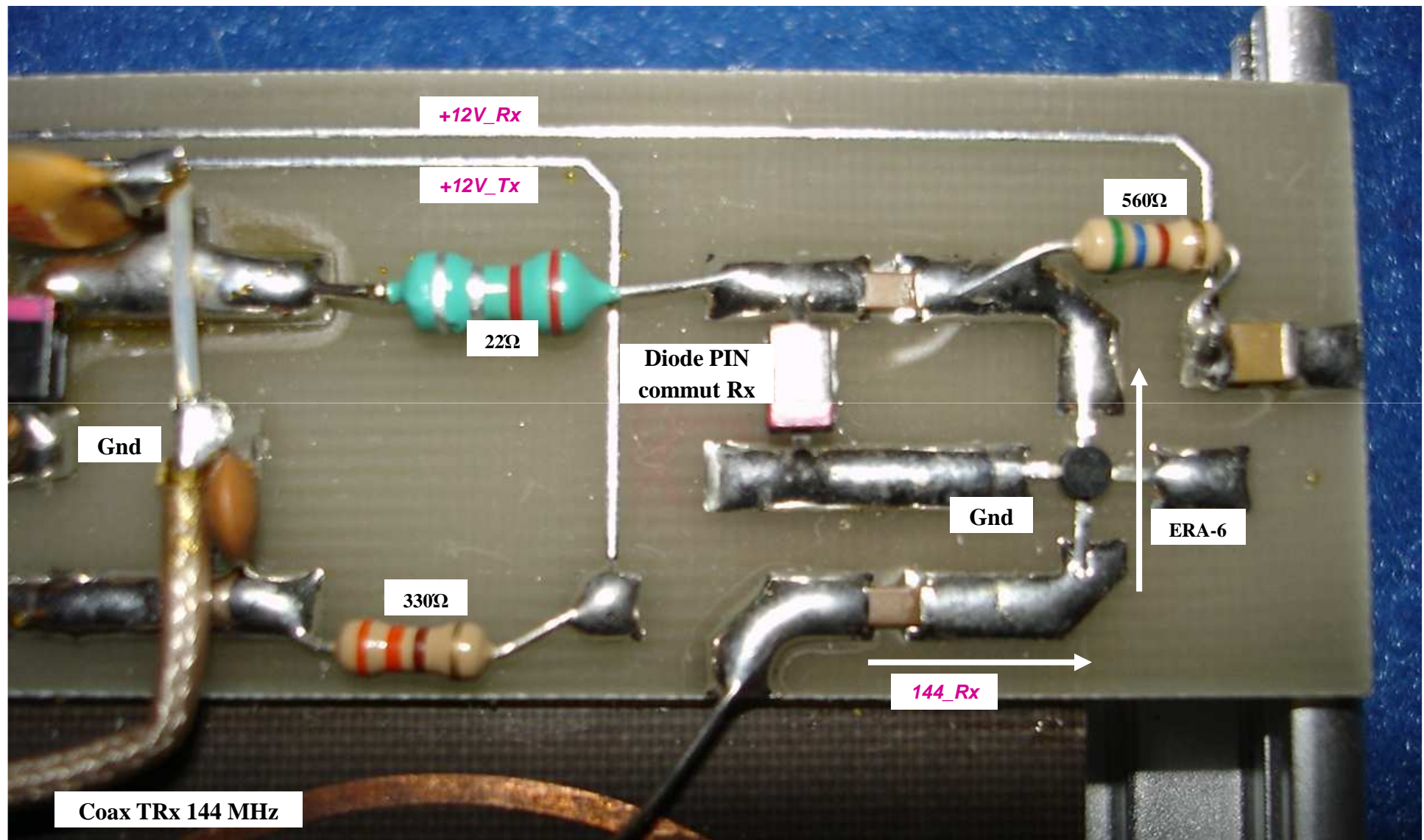

Platine de commutation PTT : «compatibilité DB6NT»

Déclenchement sur tension positive injectée en même temps que la fonction Tx

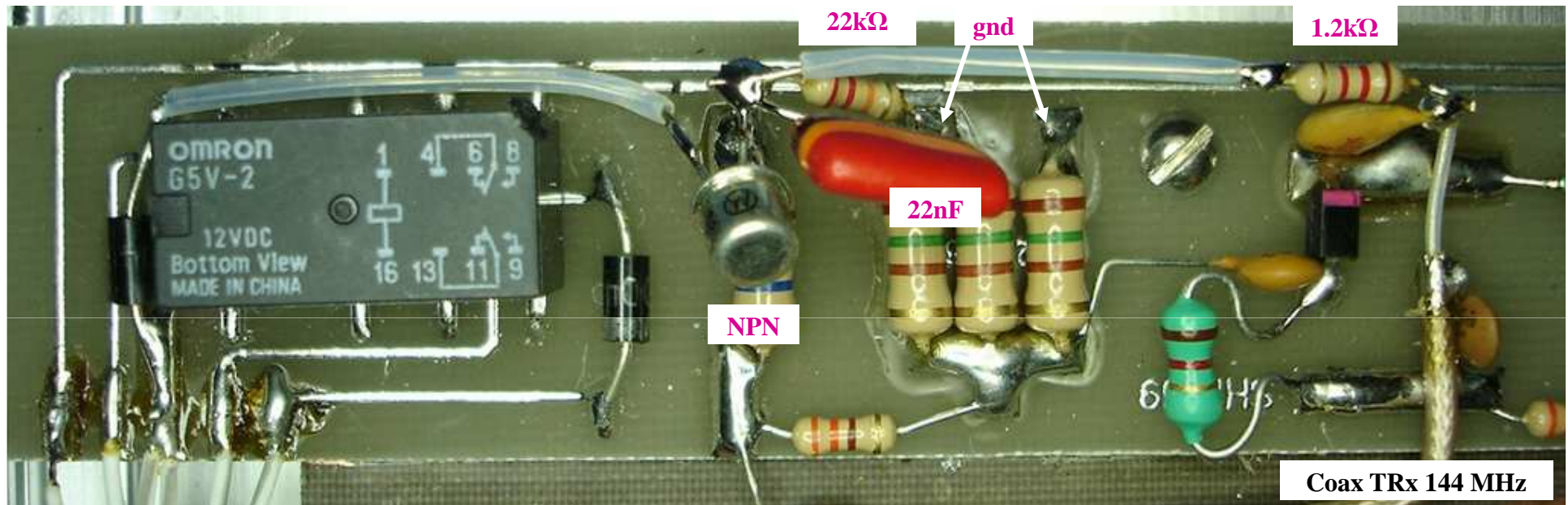

6- Améliorations apportées

Améliorations apportées

1/ Nouvelle face avant totalement repensée, réalisée par F8DLS



Avec la compatibilité Tx_DC, suppression de la fiche RCA PTT maintenant inutile



LED's bien plus petites
Visserie LO enfin totalement libre d'accès
Câblage totalement épuré
Plus aucun fil DC à proximité immédiate de la sortie du LO/4 de 544 MHz

Améliorations apportées

2/ Zoom au niveau du nouveau LNA MGA 86576 Avago

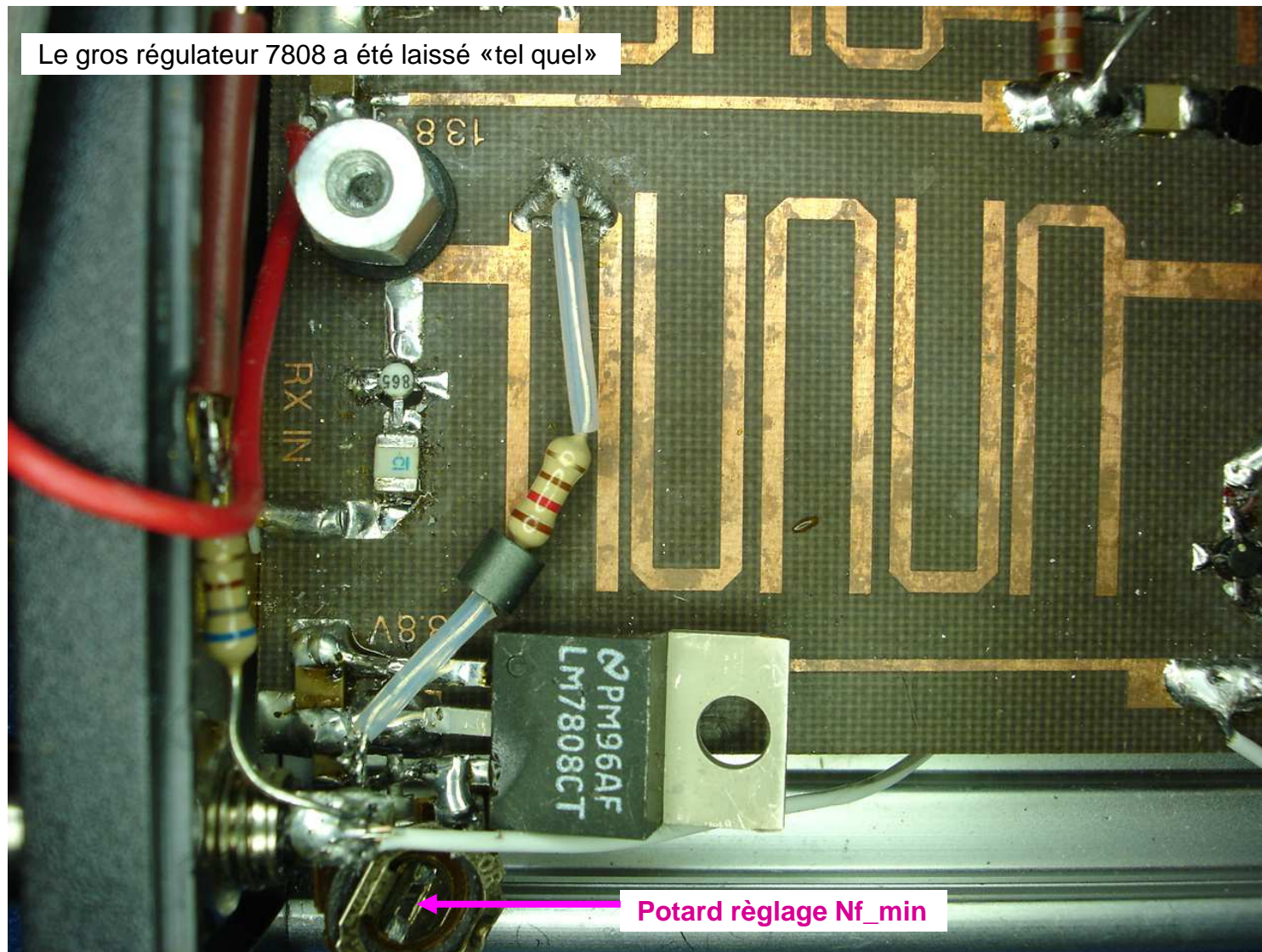

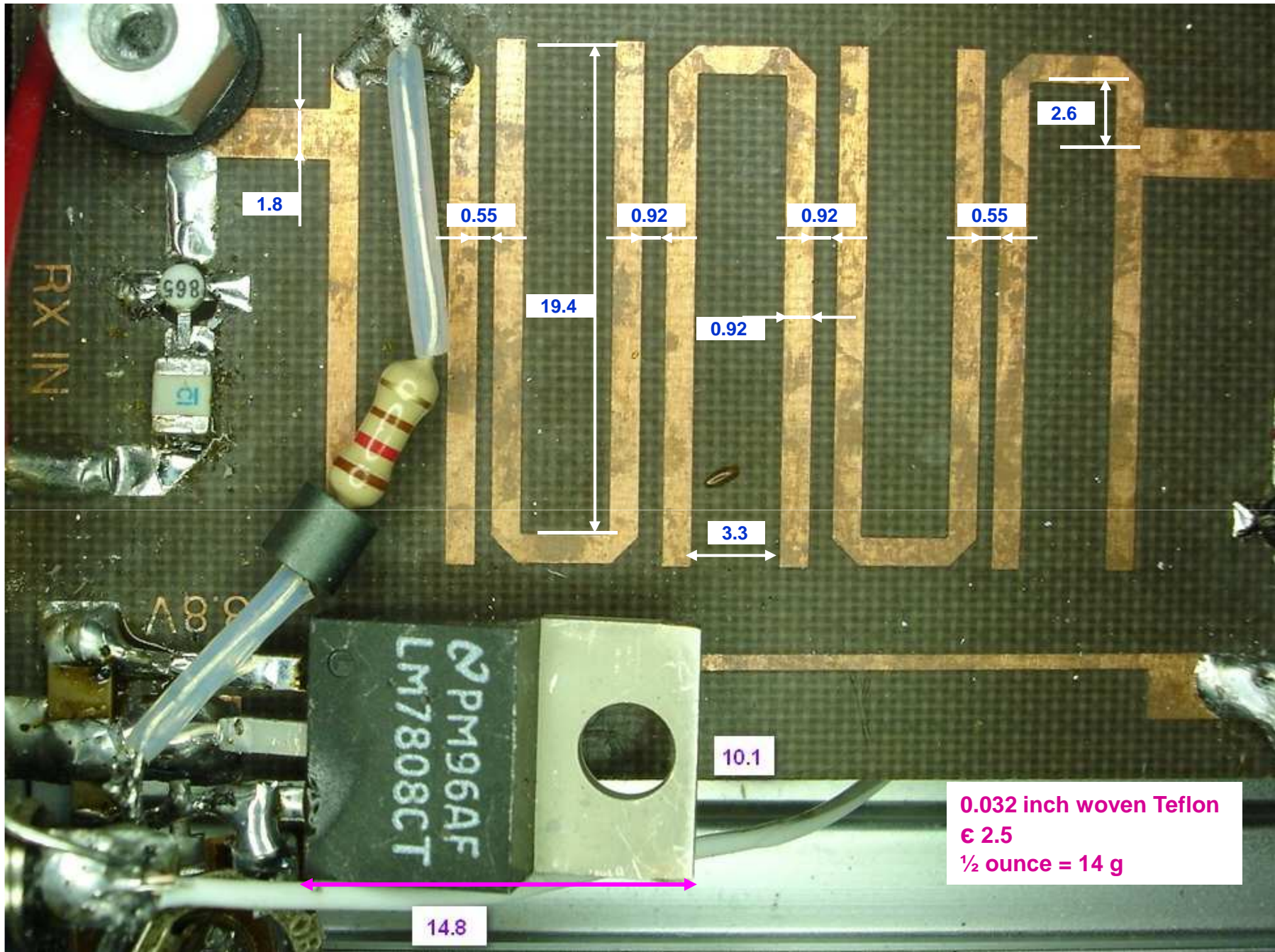

Améliorations apportées

3/ Rajout de la fonction Rx_gain

Très utile pour l'égalisation du niveau BF, en vue de ramener le S-mètre du TRx à S1 en absence de signal

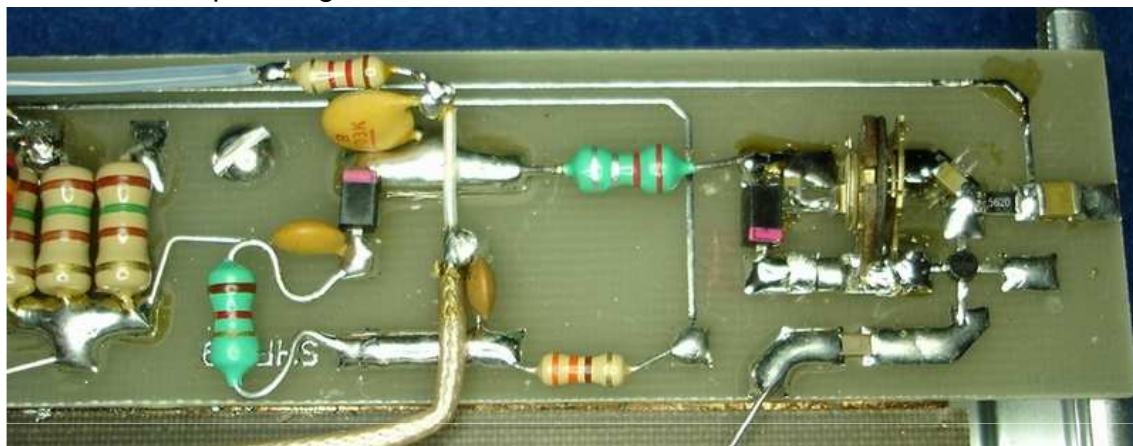

Pot à fond : 28 à 30dB
Pot à mi-course : gain muselé à 20dB

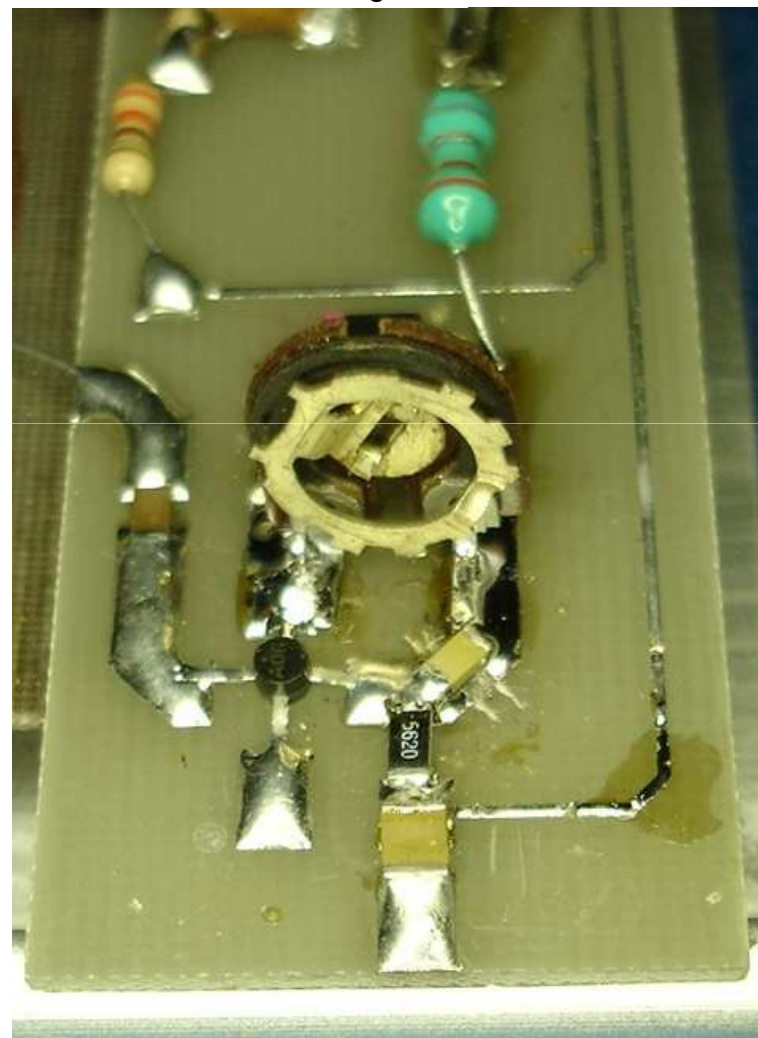

Améliorations apportées

4/ Absorbant auto-collant en **vue directe du LNA Avago**, et collé à l'arrière de la platine LO

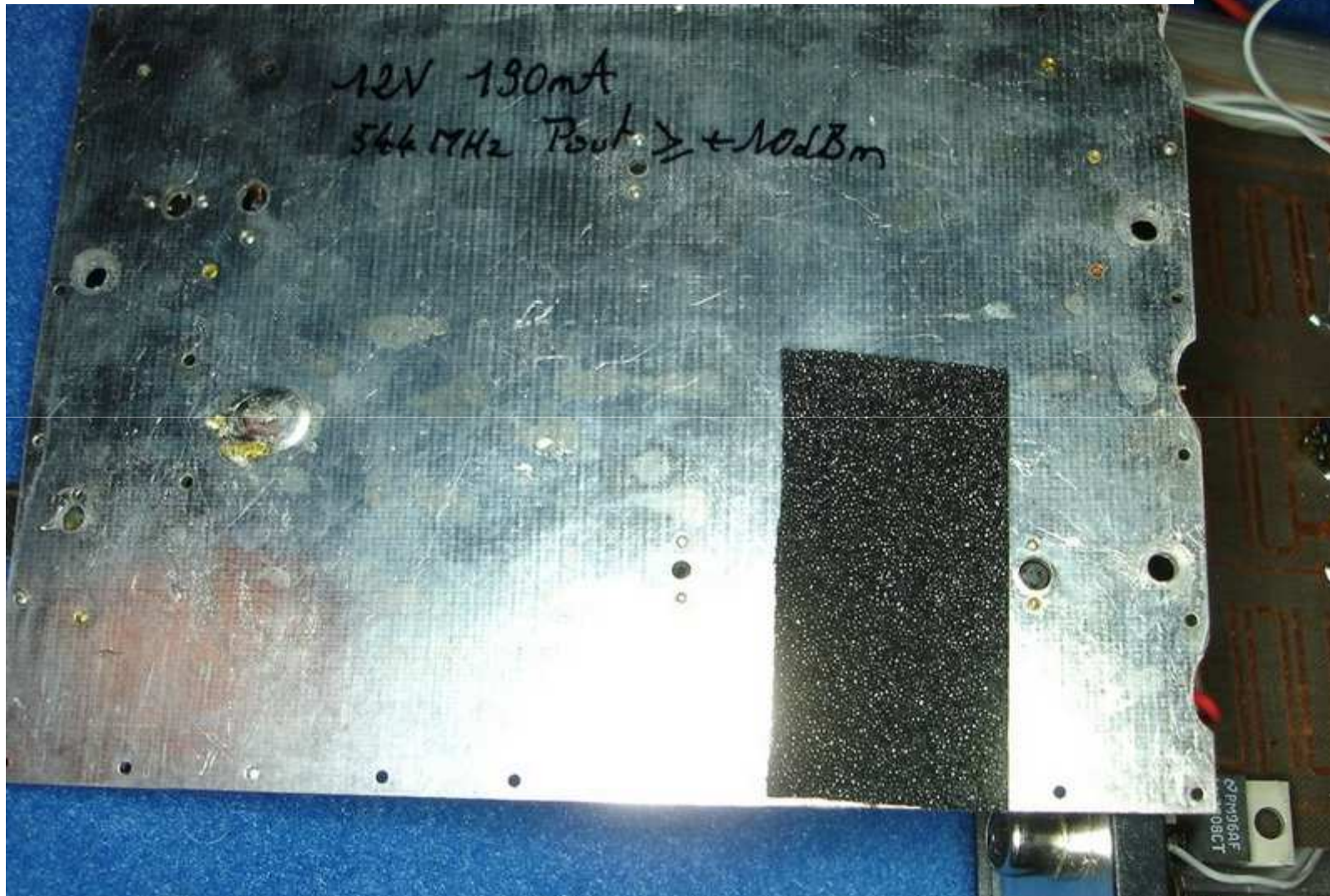

Améliorations apportées

5/ Rajout d'absorbant RF supplémentaire sur le couvercle

Tout près de la face avant, juste au-dessus de la sortie LO 566 MHz, à cause d'une remontée intempestive de Nf au moment de sa fermeture complète !



7- Conclusion, remerciements

Conclusion

Résumé des améliorations apportées côté Rx:

- Substitution du 1er étage Rx par un LNA Avago MGA 86576 (et dépose du 2ème LNA juste en aval) → le **Nf est maintenant passé de 4.5 à 2.1dB** (et encore, l'accord en amont du LNA n'a pas été rajouté)
- Rajout de la «compatibilité DB6NT» DC en Tx → plus aucun fil PTT
- Confection d'une nouvelle face avant :
 - plus sobre
 - permettant enfin un accès facile aux vis de fixation de la platine LO
- Rajout obligatoire d'absorbant autocollant RF, juste au-dessus du LNA d'entrée ainsi que sur le couvercle

A réception



Transverter seul
après transformation



Ensemble complet
(sans autre LNA
additionnel)



Conclusion

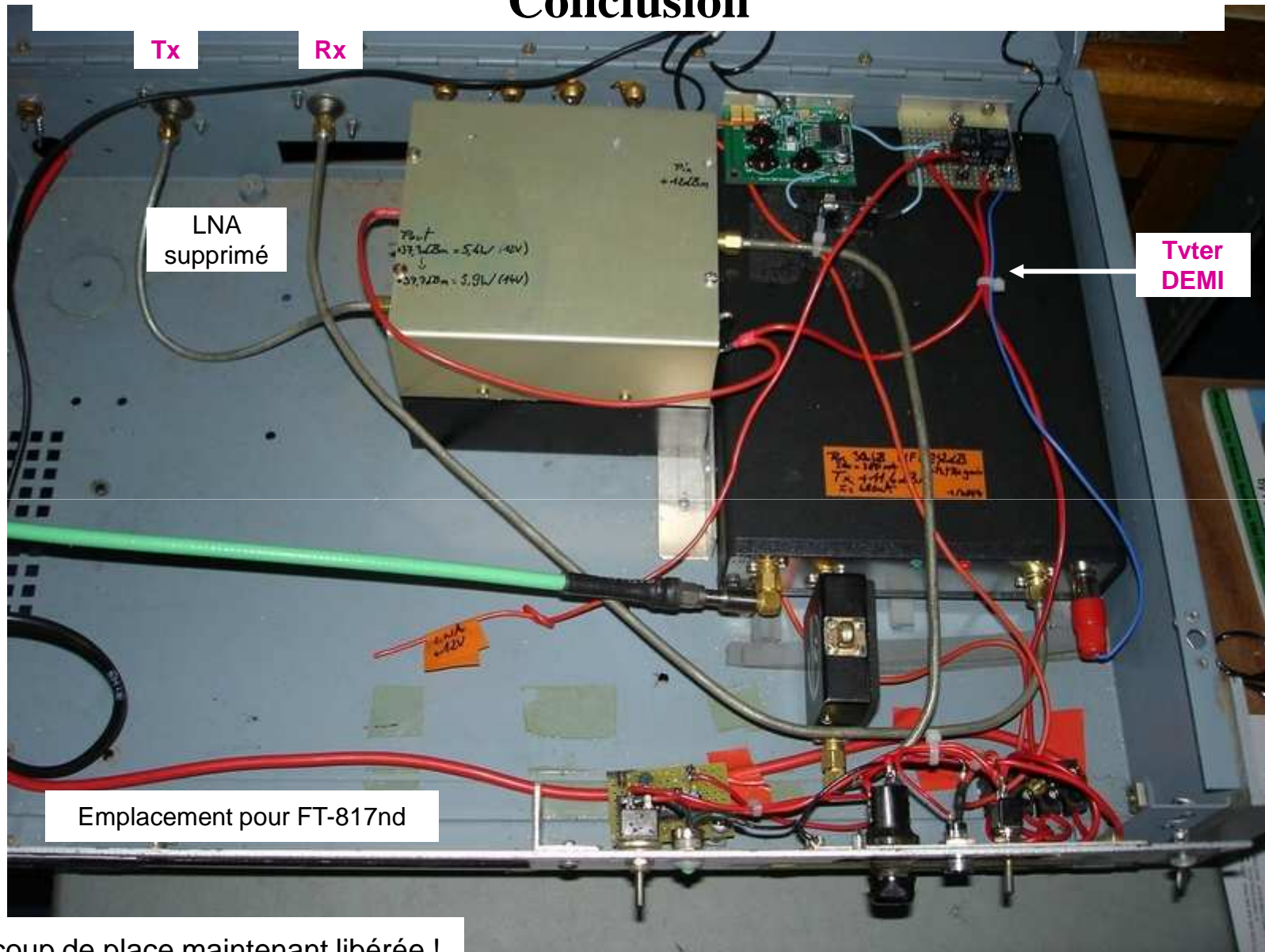

Beaucoup de place maintenant libérée !

Conclusion

Dernière remarque:

Cette version 2302 MHz US n'est malheureusement pas totalement compatible pour notre 2320 MHz EU !!

- platine LO seule : filtres interdigués OK pour bande passante considérée (539 MHz USA → 543 MHz Eur)
- platine RF mélangeuse : les filtres interdigués LO calculés pour la bande US çàd circuits 539 → 2158 MHz et non 544 → 2176 MHz, **sont donc trop longs** :

- car en substituant le LO multiplicateur interne par un synthé extérieur, le **gain Rx** :

 - reste pratiquement stable de 539.0 à 542.5 → 2168 MHz (+6dBm d'injection suffisent, circuit très stable et aucune précaution additionnelle à prévoir)

 - **décroit très rapidement au-dessus (à LO = 544 MHz bande EU, circuit vraiment très limite en stabilité)** / même avec P_LOin = +10dBm)

Remerciements

J'adresse mes sincères remerciements à Marc F8DLS, Philippe F6DQZ, André F1PYR et Jacques F6AJW

Site recommandé pour plus amples infos (surtout version plus récente) :
<http://www.downeastmicrowave.com>

8- Annexe 1 : oscillateur local PLL DF9NP

Septembre 2019

But :

Rendre ce transverter compatible Tx à 2.4 GHz sur Hailsat ou QO-100 par substitution de toute la chaîne Quartz initiale + multi par un PLL multifréquences DF9NP

Dépose de la platine supérieure Quartz + multi

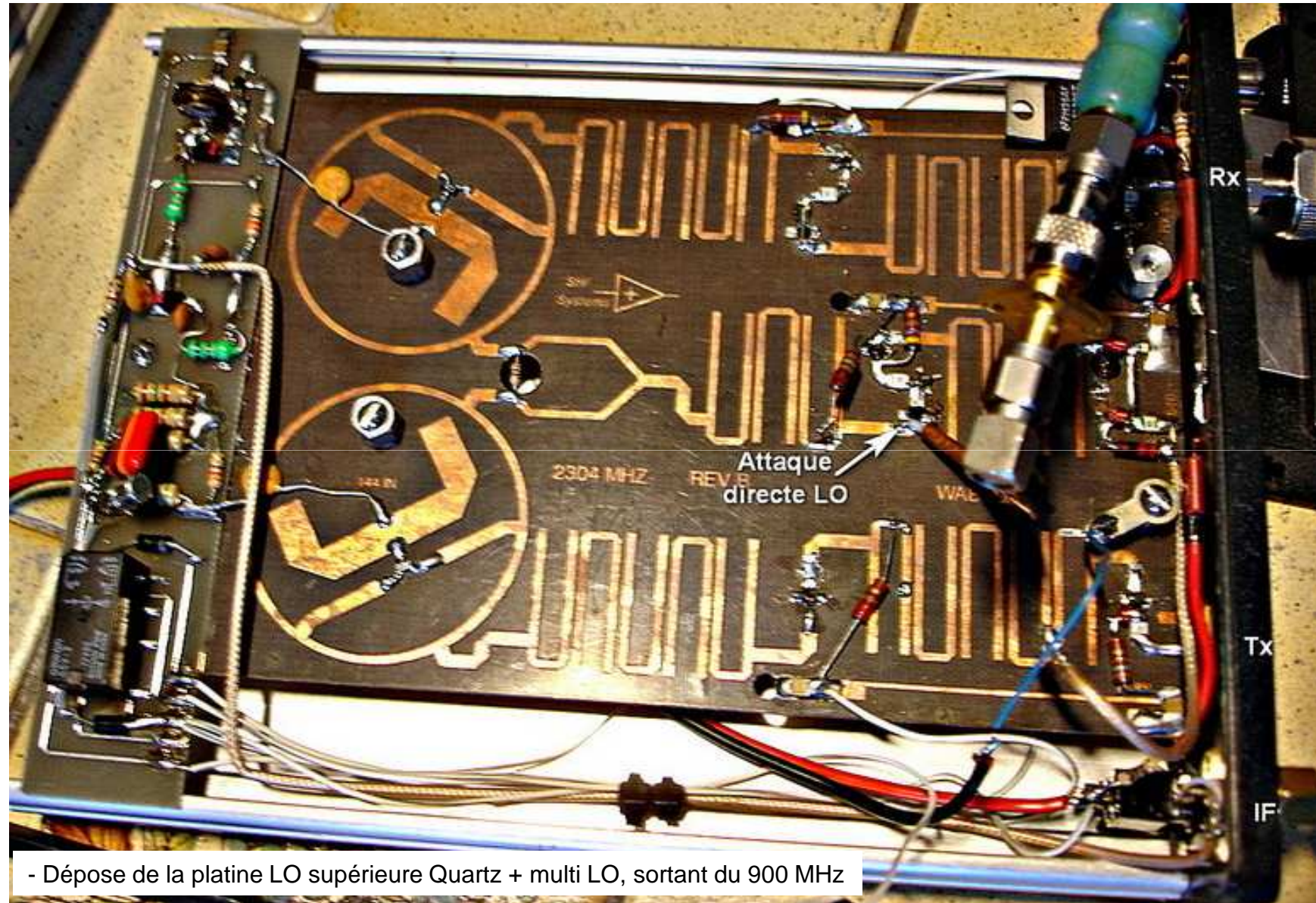

- Dépose de la platine LO supérieure Quartz + multi LO, sortant du 900 MHz

Recherche de la P_LO donnant le meilleur compromis gain/Nf

- Injection juste avant le dernier filtre Hairpin sollicitant les 2 mélangeurs Tx et Rx à diodes
- Opération effectuée dB par dB avec le Synthé Marconi 2031
- Recherche de la P_LO optimale permettant alors le meilleur compromis gain / Nf en Rx → **P_LO = +6dBm**

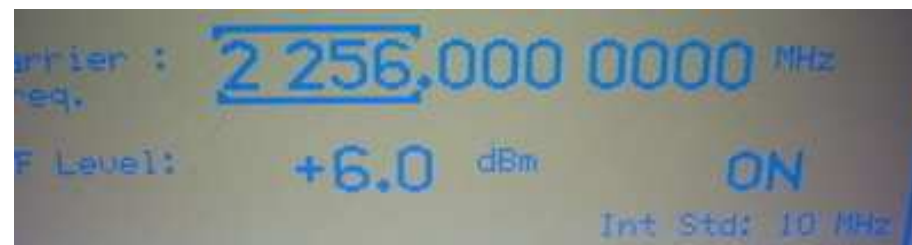

Montage du PLL DF9NP – réajustement de son attén en sortie

Pout_usine = +10.5dBm

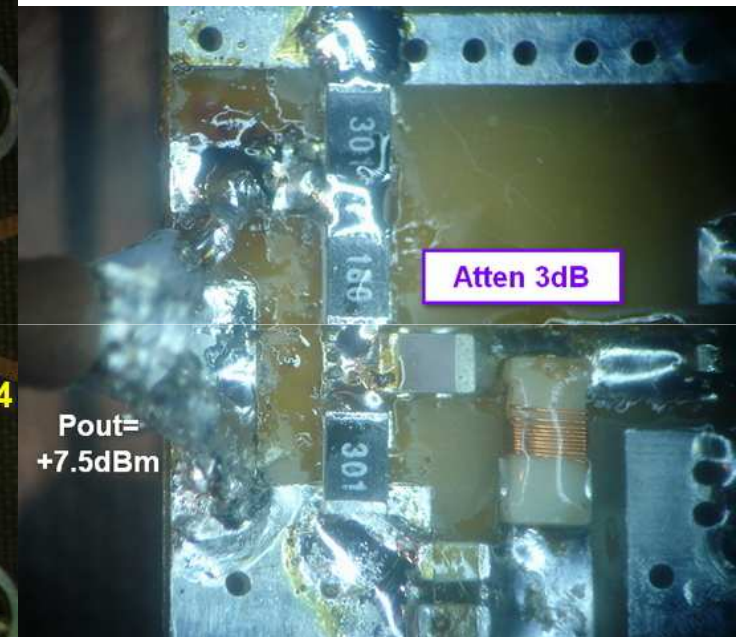
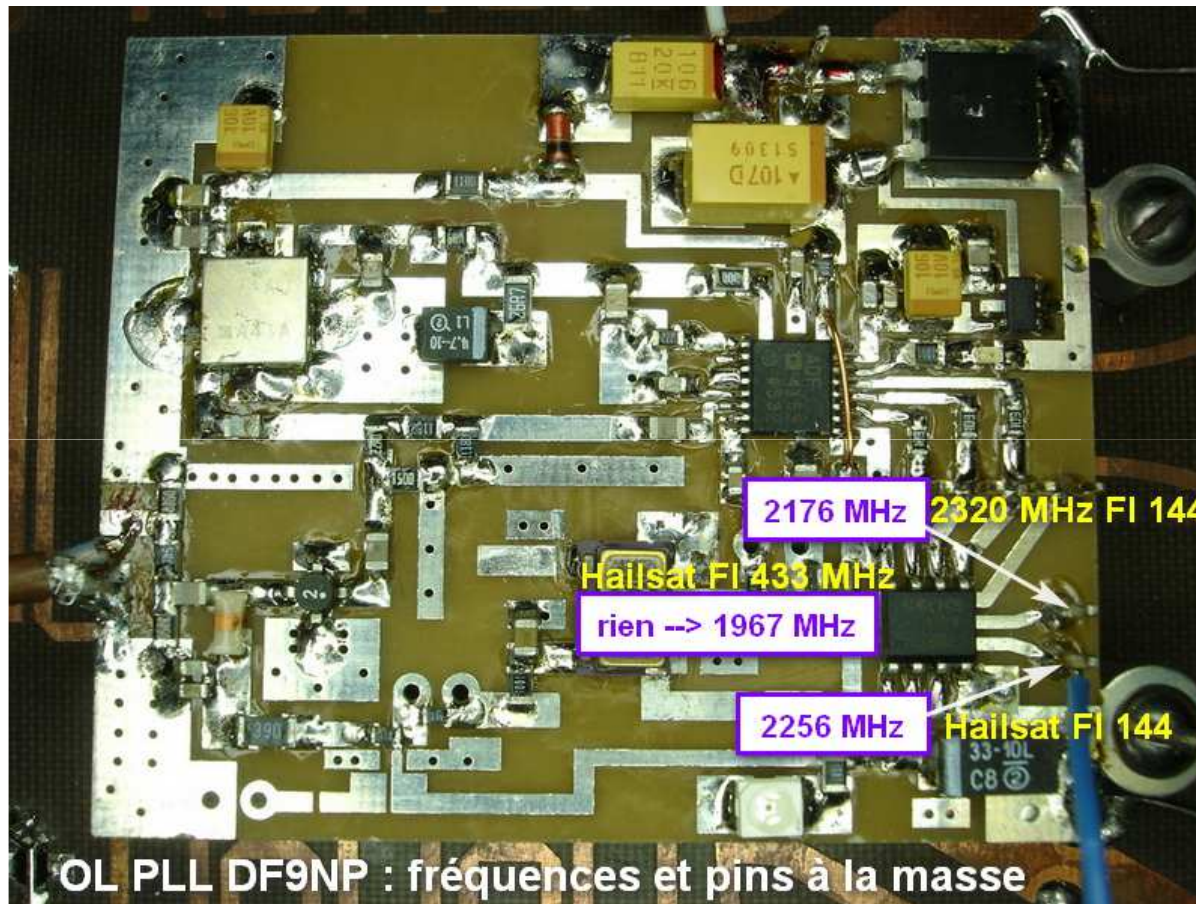

Montage du PLL DF9NP en définitif

Le tripleur + buffer sont toujours en place, mais débranchés
Perte additionnelle petit coax rouge : environ 1dB

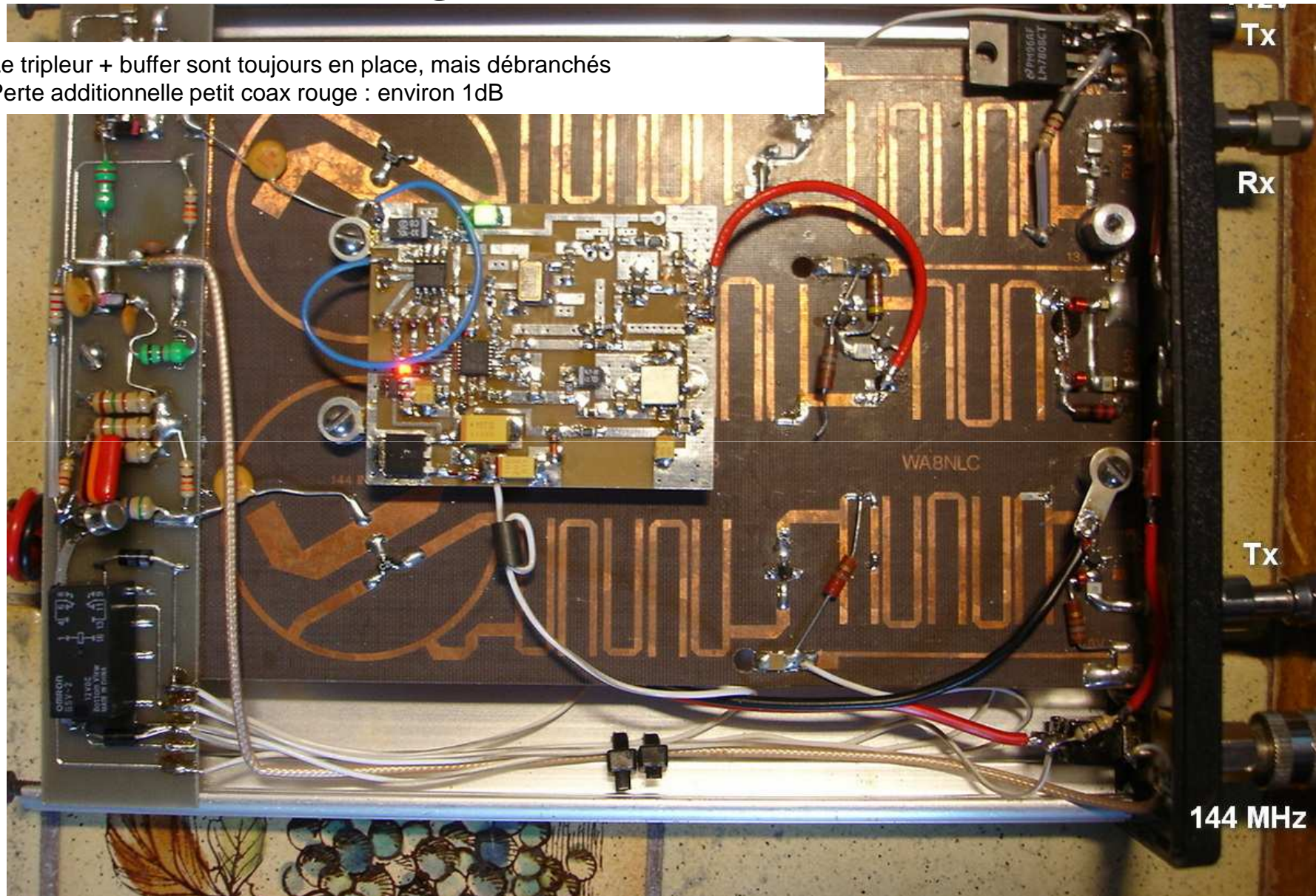

Mesure en régime Tx

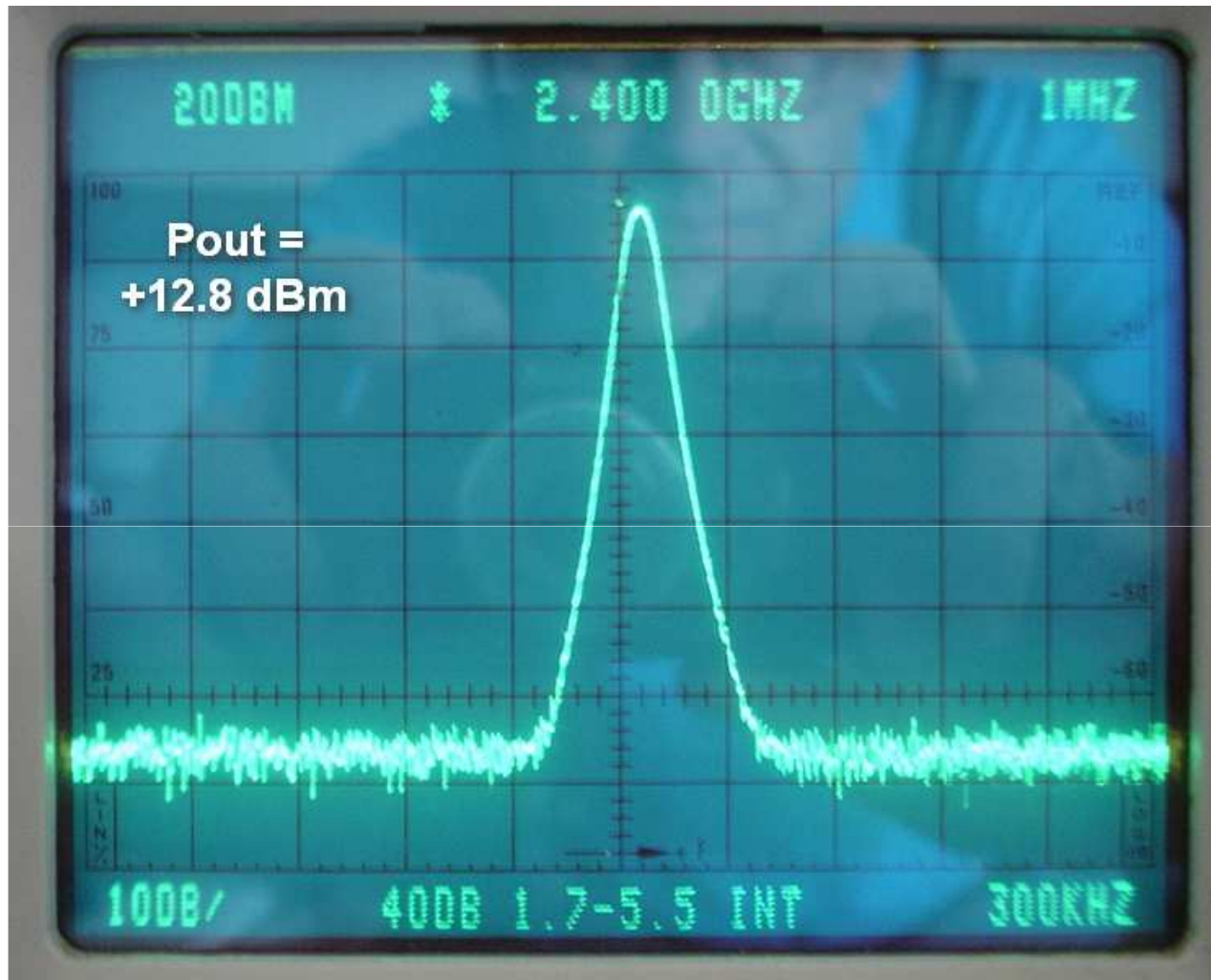

9- Annexe 2 : simulation des filtres hairpin constitutifs

- a/ Platine Tx Rx LO en verre/téflon
- b/ Platine 550 MHz ou LO/4 en verre époxy

*Logiciel Quickfilter :
Version trial disponible sur www.FilResearch.com*

a/ platine Tx Rx LO

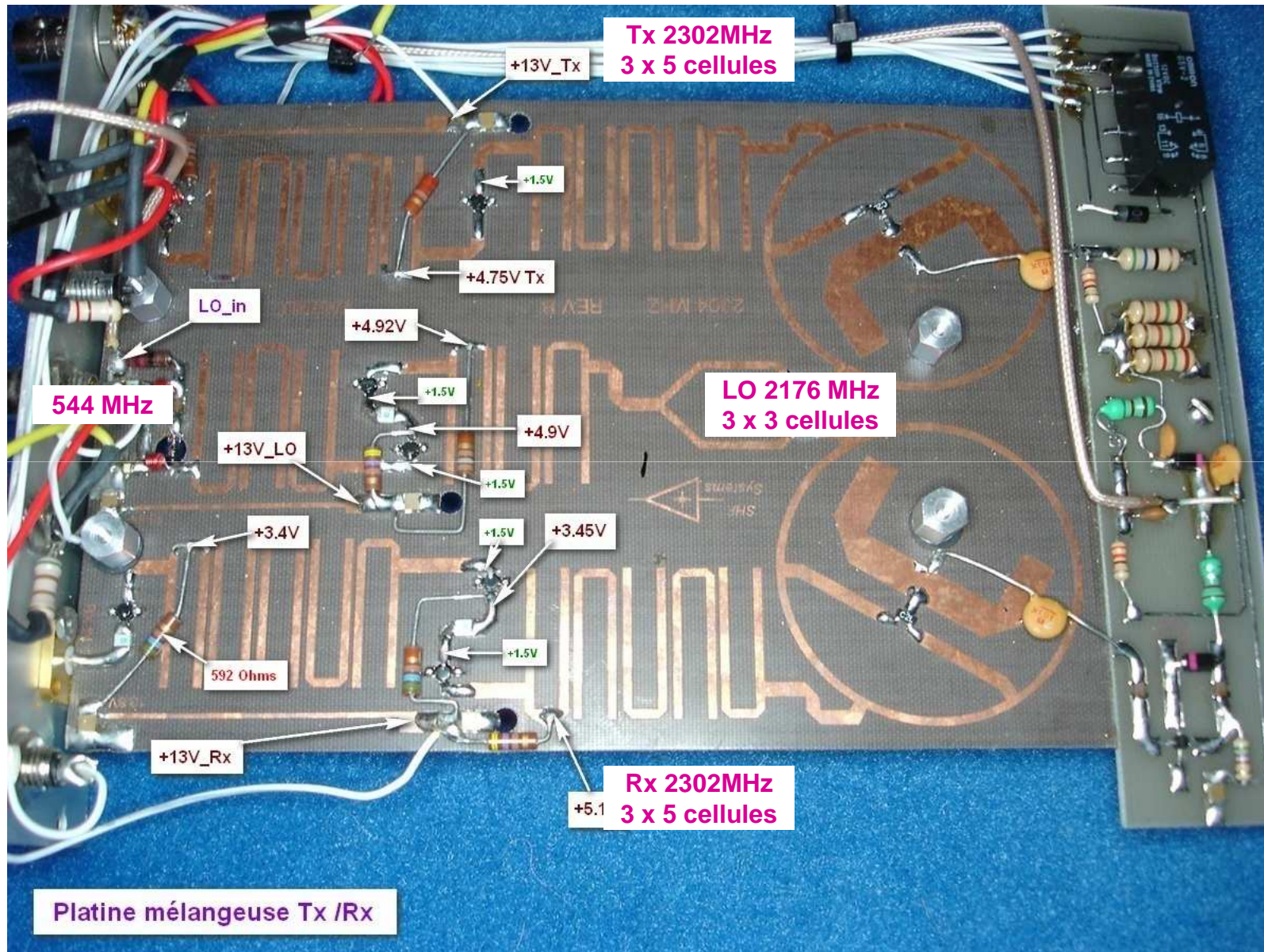

a/ platine Tx Rx LO : étude dimensionnelle

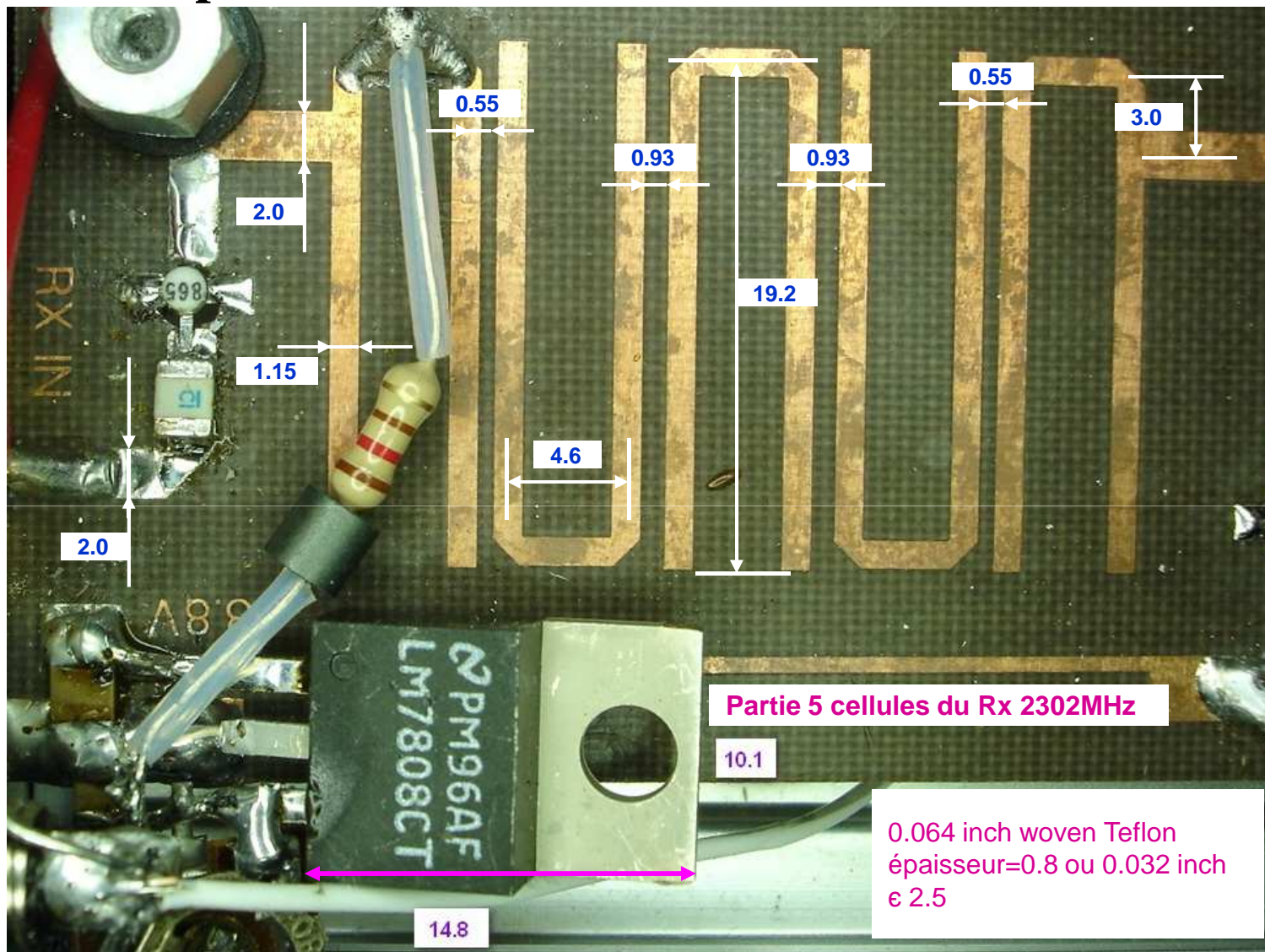

a/ platine Tx Rx LO : étude dimensionnelle

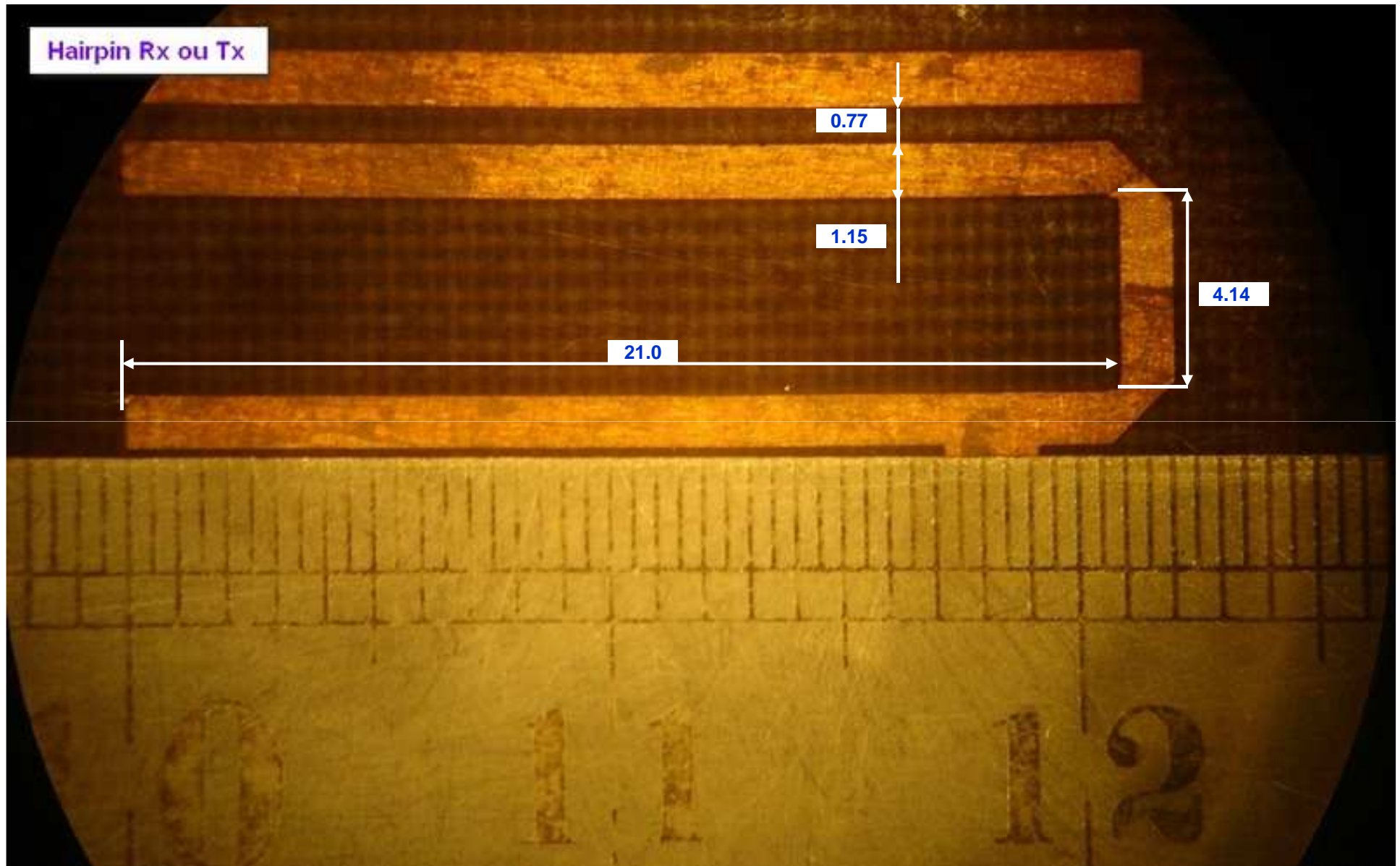

a/ platine Tx Rx LO : mesure d'un des 2 filtres 5 cellules Tx

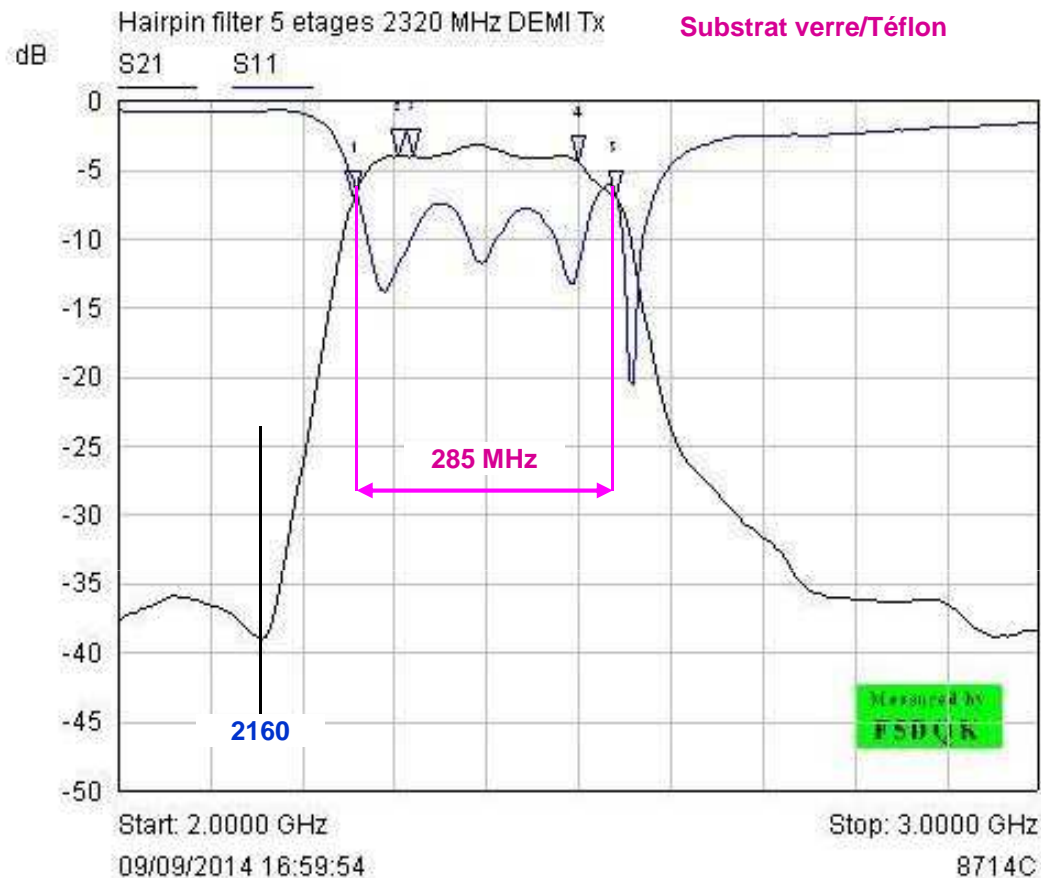

Mkr	Trace	X-Axis	Value	Notes
1 ▽	S21	2.2550 GHz	-7.09 dB	
2 ▽	S21	2.3050 GHz	-4.04 dB	
3 ▽	S21	2.3200 GHz	-4.03 dB	
4 ▽	S21	2.5000 GHz	-4.54 dB	
5 ▽	S21	2.5400 GHz	-6.99 dB	

a/ Hairpin 5 cellules à RF=2400 MHz: simu sur Quickfilter

Substrat verre/Téflon

Main Characteristics

Stage: 5 Filter Type: |

Center Freq [MHz]: 2400

Bandwidth [MHz]: 280

Ripple [dB]: 0.5

Frequency Range [MHz]

Start 1840 Stop 2960 #

Center 2400 Span 1120 4

Auto Frequency Range

Spec Line:

Start ...	End Freq	Resp Type	Condit...	Spec

Requirement + PoleZero Optimize

Microstrip

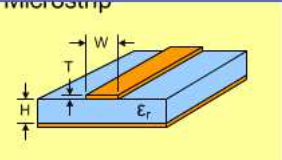

Z0 [ohm]
S
Ze [ohm]
Zo [ohm]

Design Parameter

Frequency [MHz] 2400 1.0 Wavelength

Dielectric Er 2.5 Er_eff

H 0.79 Cond x1.0E6

Project Workspace

- Sub: Microstrip
 - H = 0.79 mm
 - T = 0.01 mm
 - Er = 2.50
 - Cond = 61.67 x1.0e6 s/m
 - Tand = 1.0000 x1.0e-4
- I/O Port
 - Input
 - Z0 = 50.00 ohm
 - W = 2.23 mm
 - Output
 - I/O Coupling Type: Tapped-in
- Design Option
 - Hairpin Width: 5.08 mm
 - Corner Type: Mitered
- Circuit Parameter
- Filter Dimensions
 - Coupled Line
 - Center Line
 - # 1: W = 2.16, L = 18.16 mm
 - # 2: W = 2.16, L = 17.76, S = 0.75 mm
 - # 3: W = 2.18, L = 17.75, S = 0.95 mm
 - # 4: W = 2.18, L = 17.75, S = 0.95 mm
 - # 5: W = 2.16, L = 17.78, S = 0.75 mm
 - # 6: W = 2.16, L = 18.16 mm

September 24, 2014 07:01:28

FRI

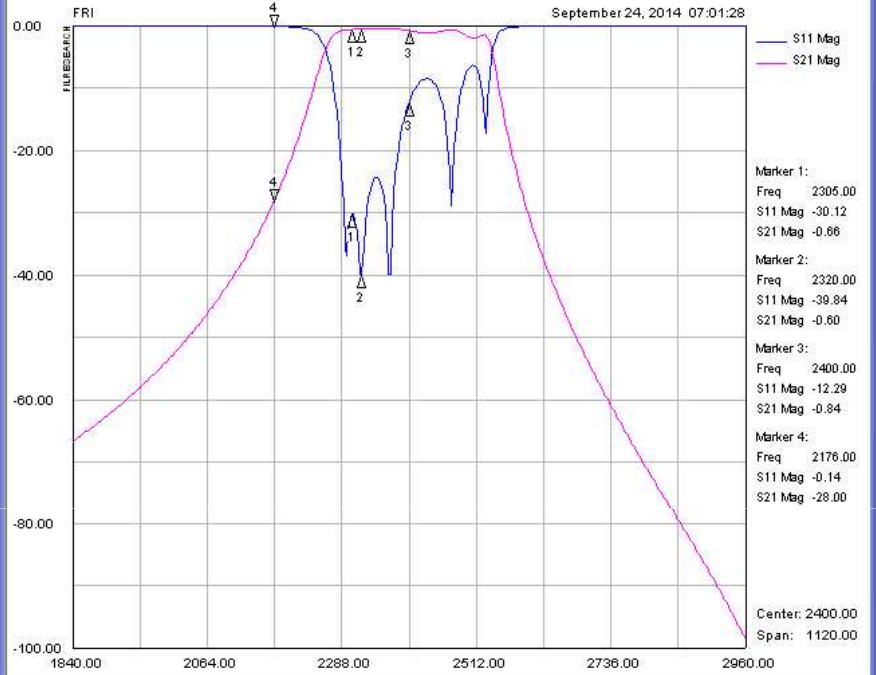

Center: 2400.00
Span: 1120.00

Marker 1:
Freq 2305.00
S11 Mag -30.12
S21 Mag -0.66

Marker 2:
Freq 2320.00
S11 Mag -39.84
S21 Mag -0.60

Marker 3:
Freq 2400.00
S11 Mag -12.29
S21 Mag -0.84

Marker 4:
Freq 2176.00
S11 Mag -0.14
S21 Mag -28.00

Layout

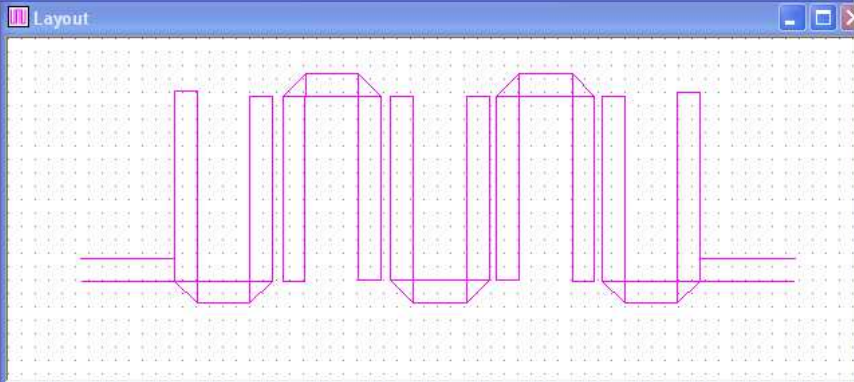

Hairpin LO

a/ platine Tx Rx LO : étude dimensionnelle

20.3



a/ platine Tx Rx LO : mesure d'un des 2 filtres 3 étages LO sup

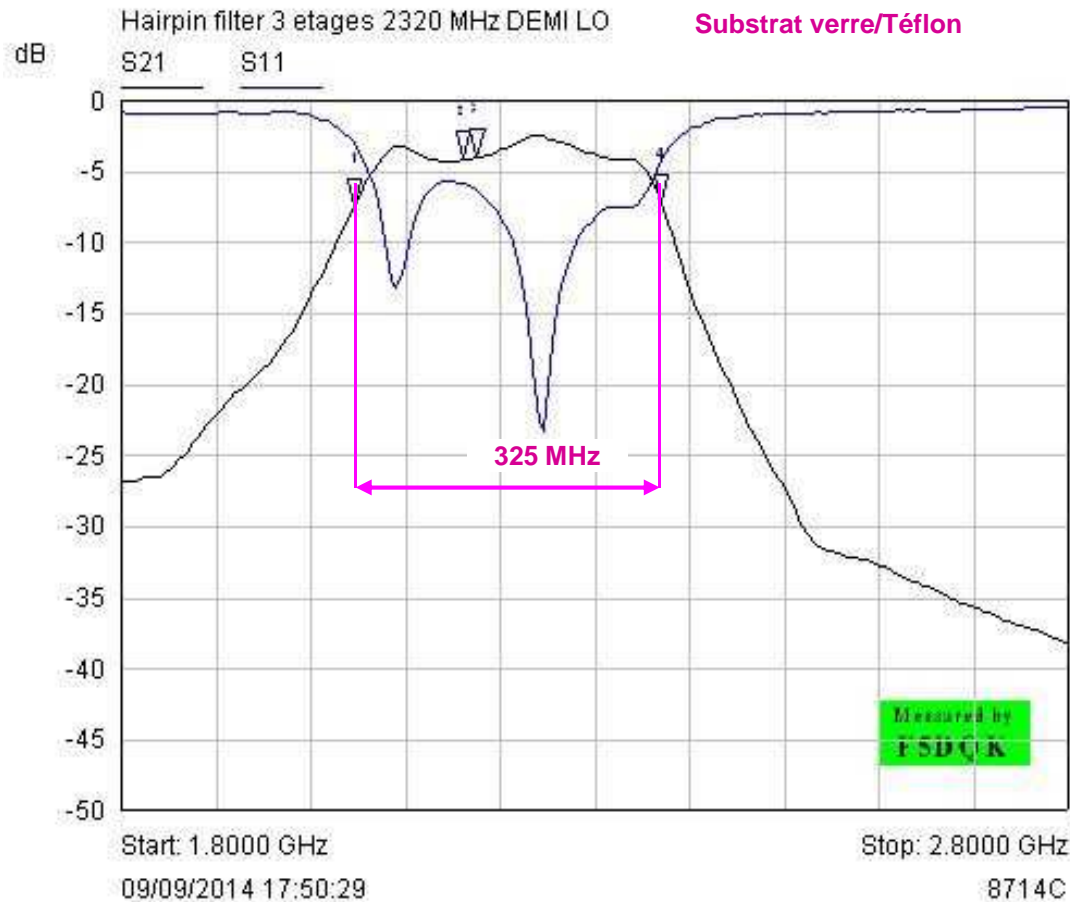

Mkr	Trace	X-Axis	Value	Notes
1 ▾	S21	2.0450 GHz	-7.53 dB	
2 ▾	S21	2.1600 GHz	-4.19 dB	
3 ▾	S21	2.1750 GHz	-4.01 dB	
4 ▾	S21	2.3700 GHz	-7.24 dB	

a/ hairpin 3 cellules à LO=2176 MHz: simu sur Quickfilter

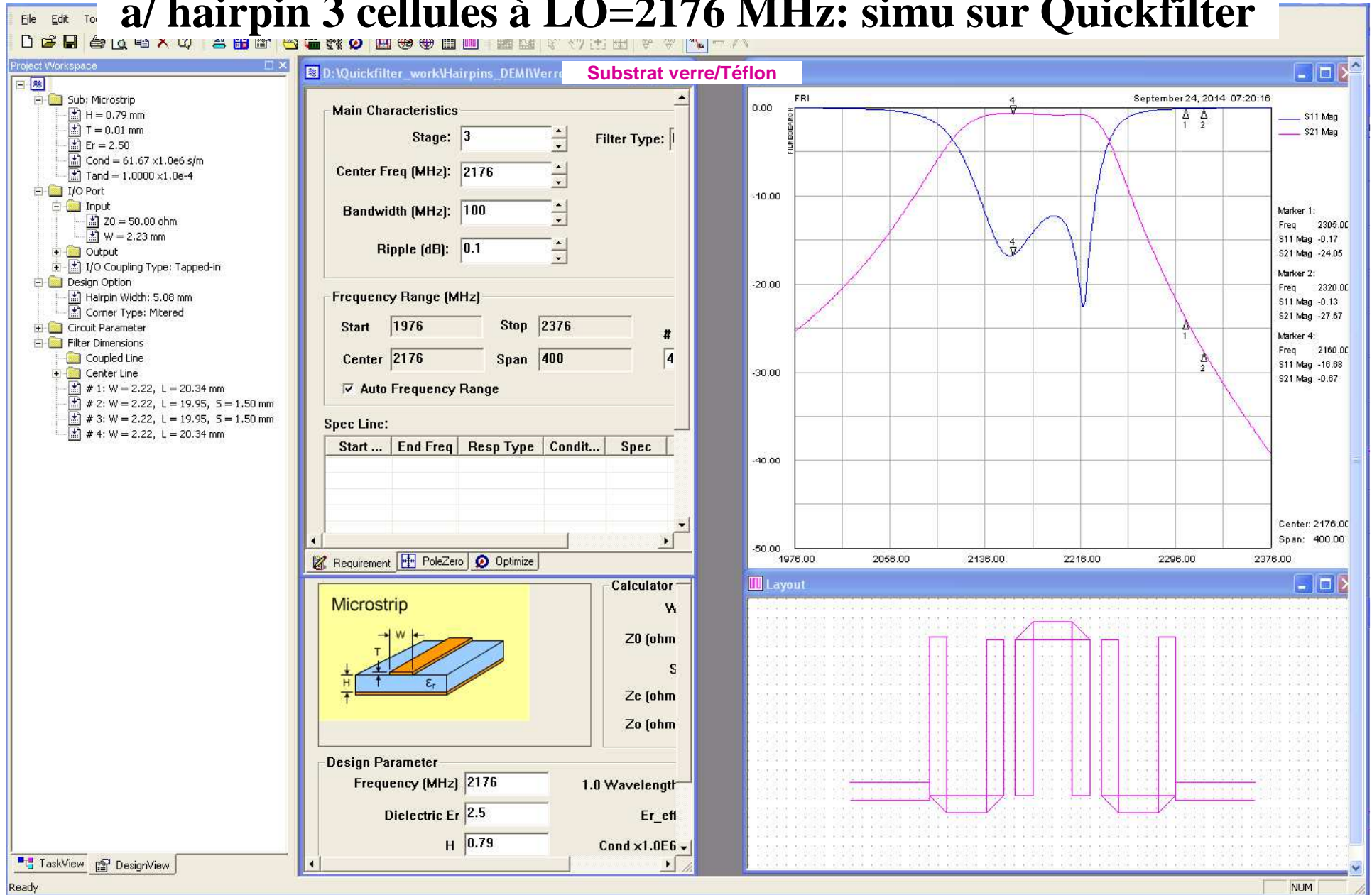

b/ platine LO 544 MHz : étude dimensionnelle

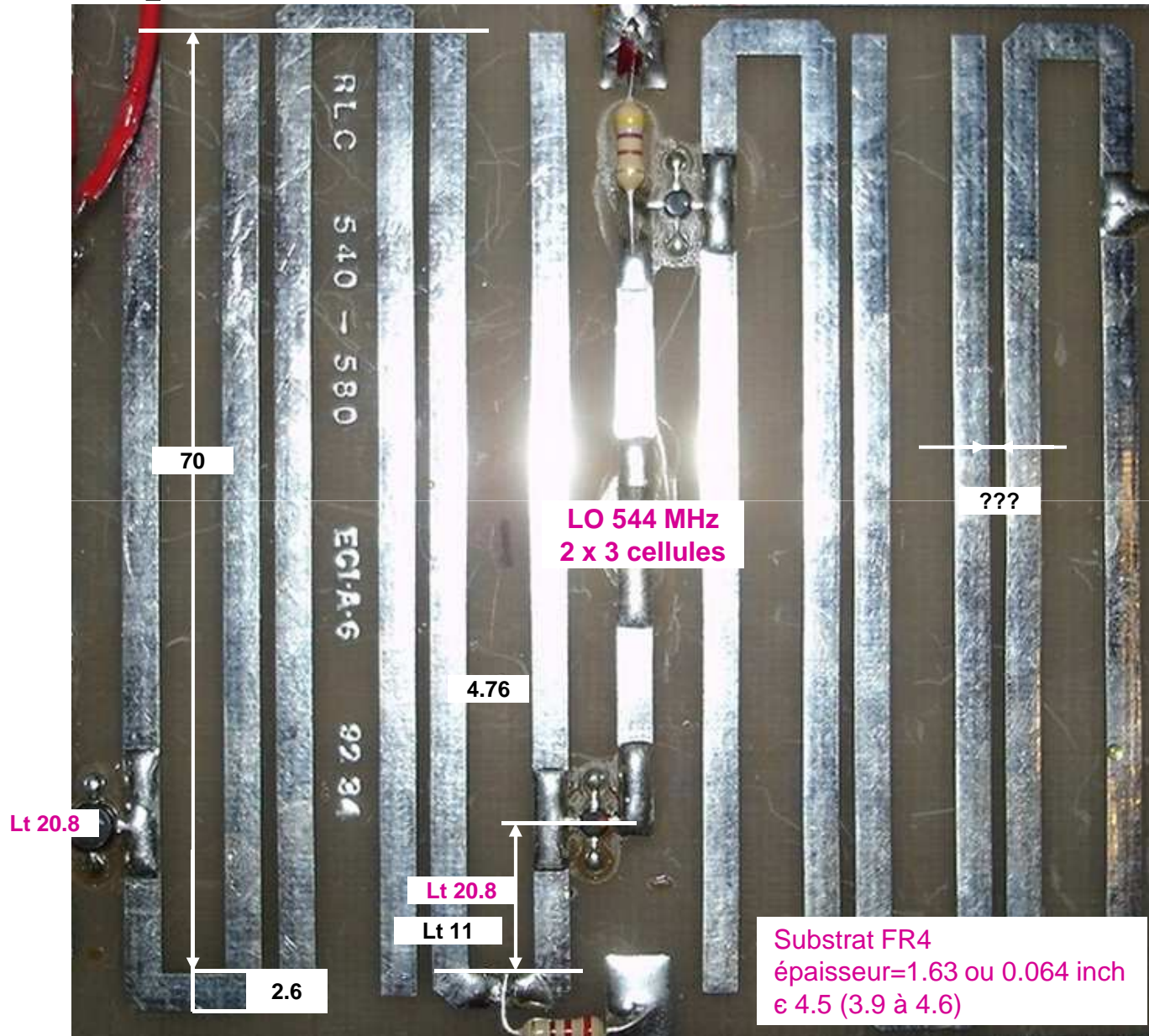

b/ platine LO : étude dimensionnelle

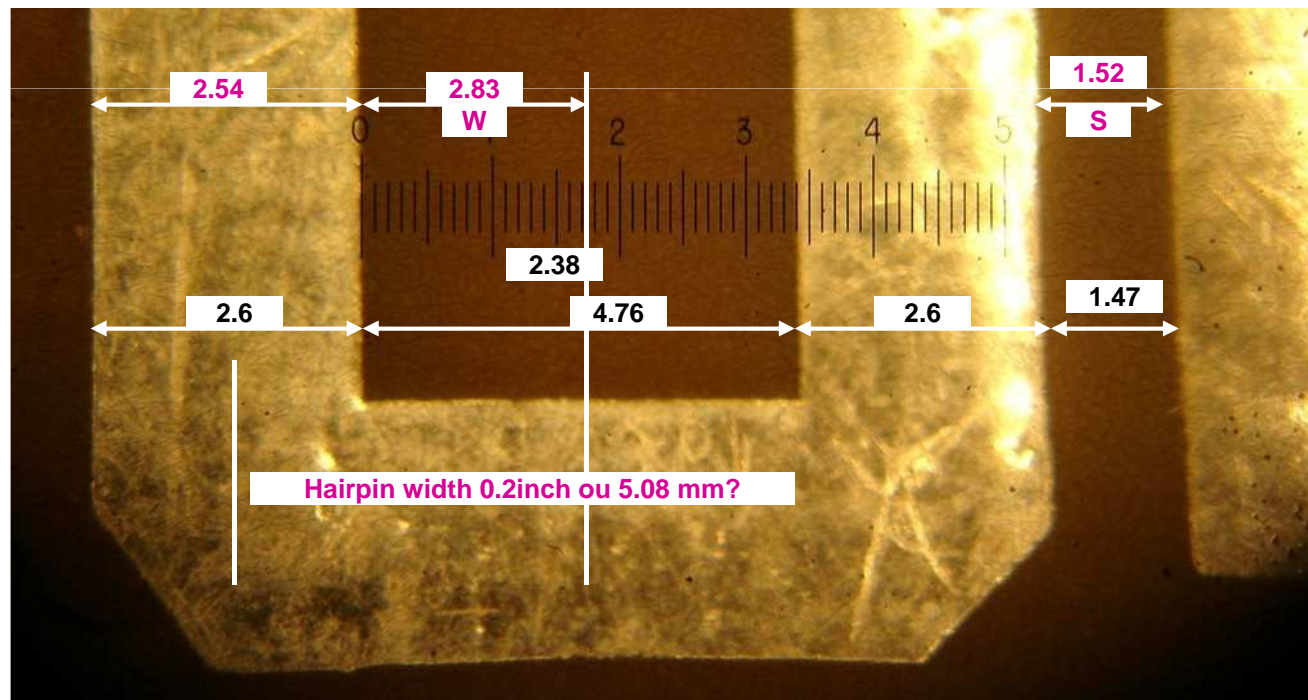
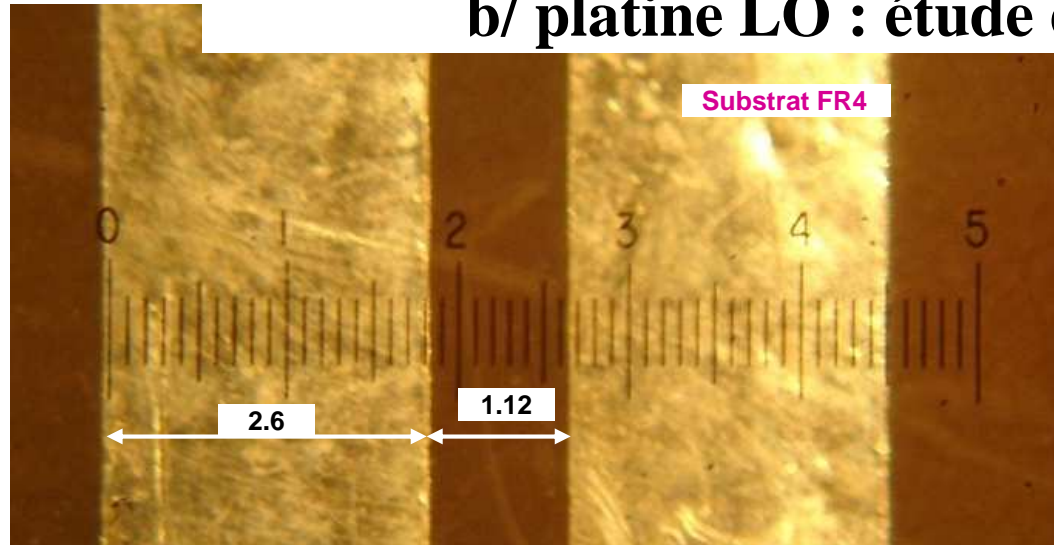

70.0 L 70.6
L_interne

1 div = 1.4mm

b/ platine LO seule 550 MHz: mesure d'un des 2 filtres 3 cellules

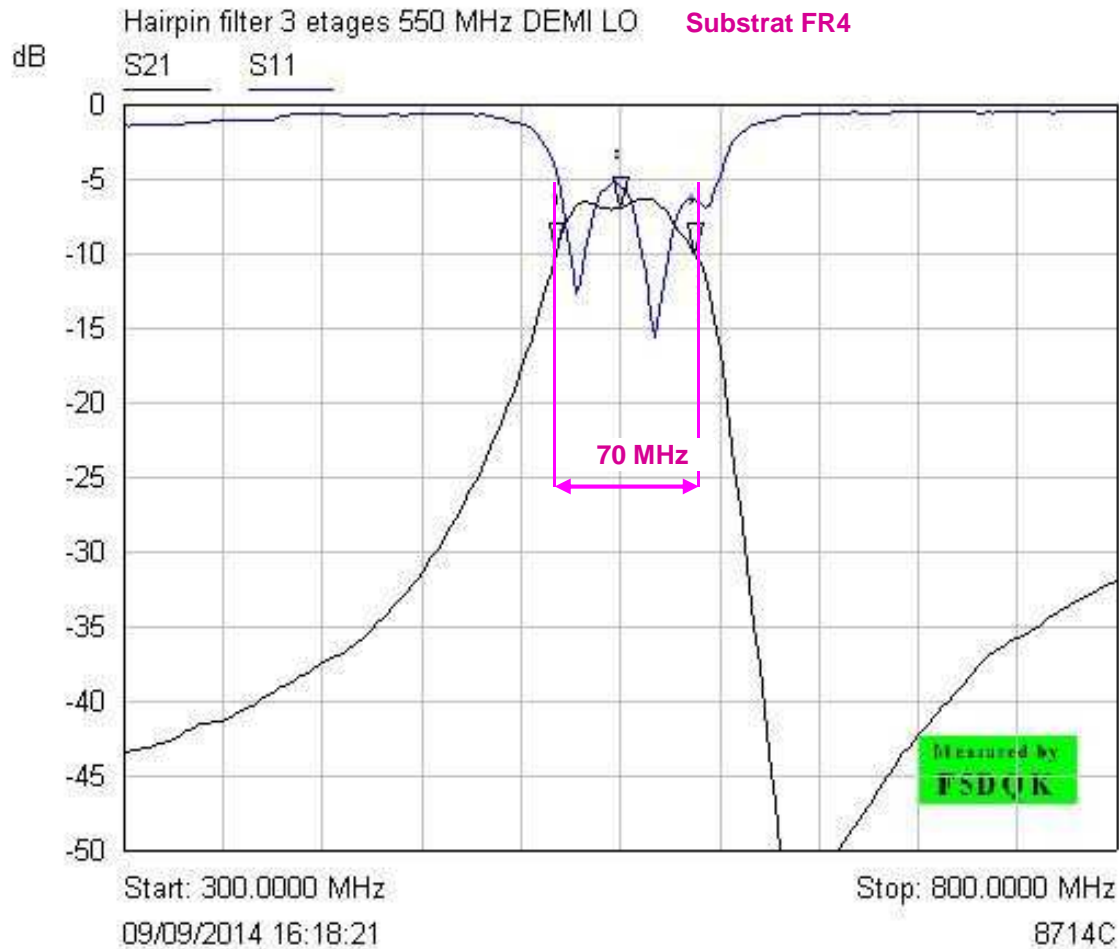

Mkr	Trace	X-Axis	Value	Notes
▾	S21	517.5000 MHz	-9.93 dB	-3dB
: ▾	S21	550.0000 MHz	-6.86 dB	
: ▾	S21	587.5000 MHz	-9.93 dB	-3dB

b/ hairpin 3 cellules à LO=550 MHz: simu sur Quickfilter

The screenshot displays the Quickfilter software interface for simulating a 3-cell hairpin filter. The main window is titled "Substrat FR-4" and shows the following parameters:

- Main Characteristics:**
 - Stage: 3
 - Filter Type: (empty)
 - Center Freq (MHz): 550
 - Bandwidth (MHz): 70
 - Ripple (dB): 0.1
- Frequency Range (MHz):**
 - Start: 410, Stop: 690
 - Center: 550, Span: 280
 - Auto Frequency Range: checked
- Spec Line:**

Start ...	End Freq	Resp Type	Condit...	Spec
- Microstrip Design Parameters:**
 - Frequency (MHz): 550
 - Dielectric Er: 4.5
 - H: 1.56
 - 1.0 Wavelength
 - Er_eff
 - Cond x1.0E6

The simulation results are shown in the "FRI" plot, which displays the magnitude of the S-parameters (S11 Mag and S21 Mag) versus frequency. The plot shows a sharp resonance dip at 550 MHz. The S11 Mag is approximately -9.70 dB and the S21 Mag is approximately -1.21 dB at the center frequency. The plot also shows the filter's response over a bandwidth of 280 MHz, from 410 MHz to 690 MHz.

The "Layout" window shows the physical layout of the filter, consisting of three parallel hairpin resonators connected in series.